

# PENTAX™

Digital Camera

# Optio 555

## Operating Manual

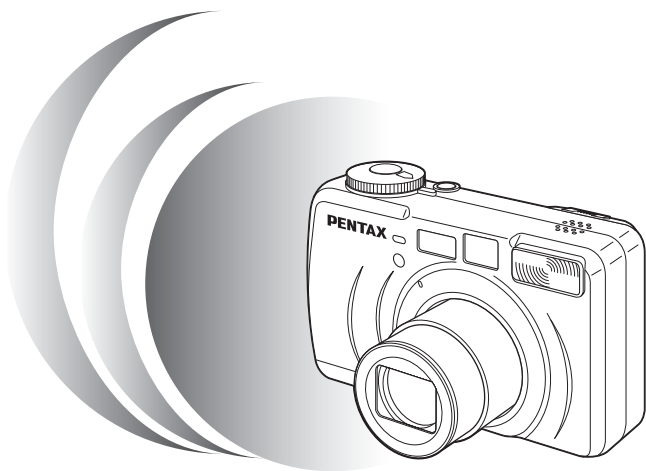

To ensure the best performance from your camera, please read the Operating Manual before using the camera.

Thank you for buying the Pentax Optio 555 Digital Camera. Please read this manual before using the camera in order to get the most out of all the features and functions. Keep this manual safe, as it can be a valuable tool in helping you to understand all the camera's capabilities.

### **Regarding copyrights**

Images taken using the Optio 555 that are for anything other than personal enjoyment cannot be used without permission according to the rights as specified in the Copyright Act. Please take care, as there are even cases where limitations are placed on taking pictures even for personal enjoyment during demonstrations, industrial enterprise or as items for display. Images taken with the purpose of obtaining copyrights also cannot be used outside the scope of use of the copyright as laid out in the Copyright Act, and care should be taken here also.

### **Regarding trademarks**

- The SD logo  is a trademark.
- PENTAX is a trademark of PENTAX Corporation.
- Optio is a trademark of PENTAX Corporation.
- All other brands or product names are trademarks of registered trademarks of their respective companies.
- This product supports PRINT Image Matching II. When used in combination, PRINT Image Matching II enabled digital still cameras, printers and software help photographers to produce images more faithful to their intentions. Copyright 2001 Seiko Epson Corporation. All Rights Reserved. PRINT Image Matching is a trademark of Seiko Epson Corporation.
- "PictBridge" allows the user to connect the printer and digital camera directly, using the unified standard for the direct printout of images. You can print images directly from the camera through a few simple operations.

This is a Class B product that complies with the standards of the Voluntary Control Council for Interference by Information Technology Equipment (VCCI). In a domestic environment, this product may cause radio and television interference when used near radio and television receiving units, in which case the user may be required to take corrective actions. Read the Operating Manual and handle properly.

- Illustrations and screenshots depicted in the Operating Manual may differ from the actual product and screens.

## FOR SAFE USE OF YOUR CAMERA

Sufficient attention has been paid to the safety of this product but please pay particular attention to the warnings indicated by the following symbols during use.



### **Warning**

This symbol indicates that it is possible that the user may experience serious difficulties if the warnings are not heeded.



### **Caution**

This symbol indicates that it is possible that the user may experience minor or middling difficulties or physical difficulties if the warnings are not heeded.



### **Warning**

- Do not attempt to take the camera apart or remodel the camera. High voltages are present within the camera, and there is therefore a danger of electric shocks.
- If the inside of the camera should become exposed as a result of, for example, the camera being dropped, please do not under any circumstances touch such exposed portions, as there is a danger of receiving an electric shock.
- Wrapping the strap of the camera around your neck is also dangerous, please take care that small children do not hang the strap around their necks.
- To avoid the risk of it being swallowed by mistake, keep the SD Memory Card out of the reach of small children. Seek medical attention immediately if accidentally swallowed.
- Use an AC adapter that are of the power and voltage specified for exclusive use with this product. The use of an AC adapter other than that specified exclusively for use with this product may cause fire or electric shocks.
- If the camera emits smoke or a strange smell, or in the event of any other irregularity, stop using the camera immediately, remove the battery or disconnect the AC adapter and contact your nearest Pentax service center. Continued use of the camera may result in fire or electric shock.
- Discontinue use of the AC adapter during thunderstorms. This can cause a fire or electrical shock.

## **Caution**

- Never try to disassemble, short the battery. Also, do not dispose of the battery in fire, as it may explode.
- Remove the battery from the camera immediately if it becomes hot or begins to smoke. Be careful not to burn yourself during removal.
- Some portions of the camera heat up during use, so please take care, as there is a risk of low temperature burns if such portions are held for long periods of time.
- Do not place your finger on the flash when it is discharging as there is a risk of burns.
- If any of the battery leakage should come in contact with your eyes, do not rub them. Flush your eyes with clean water and get medical attention immediately.
- If any of the battery leakage should come in contact with skin or clothes, wash the affected areas thoroughly with water.

## **Care to be Taken During Handling**

- Do not clean the product with organic solvents such as thinner or alcohol benzene.
- Places of high temperature and humidity should be avoided. Particular care should be taken regarding vehicles, which can become very hot inside.
- Storing the camera where pesticides and chemicals are handled should be avoided.  
Remove from case and store in a well-ventilated place to prevent the camera from becoming moldy during storage.
- Do not use the camera where it may come in contact with rain, water or any other liquid, because the camera is not weather, water, or liquid resistant. Should the camera get wet from rain, splashing water, or any other liquid, wipe it off immediately with a dry soft cloth.
- Ensure that the camera is not subjected to substantial vibrations, shocks or pressure.  
Place the camera on a cushion for protection when the camera is subjected to the vibrations of a motorbike, car, or ship, etc.
- The liquid crystal display will become black at temperatures of approximately 60°C (140°F) but will return to normal when normal temperatures are returned to.

- The response speed of the liquid crystal display becomes slow at low temperatures.  
This is due to the properties of the liquid crystal and is not a fault.
- Remove dust from the lens and viewfinder using a blower or clean off dust using a lens brush.
- Periodic checks are recommended every 1 to 2 years in order to maintain high-performance.
- When the camera has not been used for a long time, confirm that it is still working properly, particularly prior to taking important pictures (such as at a wedding or during travelling). Pentax is not responsible for consequential damages (costs incurred as a result of taking pictures, loss of benefits that were to be obtained through taking pictures) arising from failure of this product.
- If the camera is subjected to rapid temperature changes, condensation may form on the inside and outside of the camera. Therefore put the camera in a bag or plastic bag, and take the camera out when the difference in temperature has subsided.
- The temperature range in which the camera can be used is 0°C to 40°C (32°F to 104°F).
- Avoid contact with garbage, dirt, sand, dust, water, toxic gases, salt, etc. as this may cause damage to the camera. If rain or drops of water get onto the camera, please wipe dry.
- Refer to "Precautions When Using a SD Memory Card / MultiMediaCard" (p.17) regarding the SD Memory Card / MultiMediaCard.
- Be sure to use the rechargeable lithium-ion battery D-LI7 provided for this camera. If you use any other battery the camera may be damaged or malfunction.

### **To users of this camera**

- There is a possibility that recorded data may be erased or that the camera may not function correctly when used in surroundings such as installations generating strong electromagnetic radiation or magnetic fields.
- The liquid crystal panel used in the LCD display is manufactured using extremely high precision technology. Although the level of functioning pixels is 99.99% or better, you should be aware that 0.01% or fewer of the pixels may not illuminate or may illuminate when they should not. However, this has no effect on the recorded image.
- There is a possibility that the illustrations and the display screen of the LCD monitor in this manual are different from the actual product.

# Contents

FOR SAFE USE OF YOUR CAMERA .....	1
Care to be Taken During Handling .....	2
Contents .....	4
Contents of the operating manual .....	7
Checking the Contents of the Package .....	8
Names of Parts .....	9
Names of Operating Parts .....	10
<b>Getting Started</b> .....	<b>11</b>
<b>Attaching the Strap</b> .....	<b>11</b>
<b>Powering the Camera</b> .....	<b>12</b>
Charging the Battery .....	12
Installing the Battery .....	13
Using the AC Adapter (optional) .....	15
<b>Installing the SD Memory Card / MultiMediaCard</b> .....	<b>16</b>
<b>Turning the Camera On and Off</b> .....	<b>18</b>
Play back Only Mode .....	18
<b>Adjusting the Viewfinder</b> .....	<b>19</b>
<b>Initial Settings</b> .....	<b>20</b>
Setting the Display Language .....	20
Setting the Home Town .....	21
Setting the D.S.T. Mode .....	21
Setting the Date and Time .....	22
<b>Quick Start</b> .....	<b>24</b>
Playing Back Images .....	26
Playing Back Previous or Next Images .....	27
<b>Common Operations</b> .....	<b>30</b>
<b>Changing the Mode</b> .....	<b>30</b>
<b>Using the Button Functions</b> .....	<b>31</b>
Capture Mode .....	31
Playback Mode .....	33
<b>Using the Menus</b> .....	<b>34</b>
How to Set the Menus .....	34
Menu List .....	36
<b>Taking Pictures</b> .....	<b>38</b>
<b>Displaying Shooting Information (Capture Mode)</b> .....	<b>38</b>
<b>Setting the Shooting Functions</b> .....	<b>40</b>
Selecting the Focus Mode .....	40
Selecting the Flash Mode .....	42
Selecting the Recorded Pixels .....	43
Selecting the Quality Levels .....	44
Adjusting the Color Balance according to Lighting (White Balance) .....	45

Changing the AF Area (Focusing Area) .....	47
Setting the Light Metering Range to Determine the Exposure (AE Metering) .....	48
Setting the Sensitivity .....	49
Setting the Instant Review time (Instant Review) .....	50
Setting the Image Sharpness (Sharpness).....	50
Setting the Sensitivity .....	50
Setting the Color Saturation (Saturation).....	51
Setting the Image Contrast (Contrast).....	51
Adjusting the Flash Output .....	52
<b>Taking Pictures .....</b>	<b>53</b>
Letting the Camera Set the Exposure (Program Mode) .....	53
Setting the Aperture Value (Aperture-Priority Mode).....	54
Setting the Shutter Speed (Shutter-Priority Mode) .....	55
Setting the Exposure Manually (Manual Exposure Mode) .....	56
Using Preset Function Settings (User Mode) .....	58
Registering Functions in User Mode .....	59
Selecting the Picture Mode According to the Shooting Scene (Picture mode) .....	60
Taking Panorama Pictures (Panorama Assist Mode).....	62
Taking Stereo Pictures (3D Image Mode) .....	64
Recording Sound (Voice Recording Mode).....	69
Taking Pictures with Digital Filters (Digital Filter Mode) .....	70
Taking Movie Pictures (Movie Picture Mode).....	72
Using the Zoom .....	74
EV Compensation.....	76
Using the Self-timer .....	77
Using the Remote Control Unit (optional).....	78
Continuous Shooting .....	79
Taking Pictures at Fixed Intervals (Interval Shooting) .....	80
Superimposing One Picture on Top of Another (Multiple Exposure Mode).....	82
Automatically Changing the Shooting Conditions (Auto bracket) ...	84
Taking Fast Forward Movie Pictures (Fast Fwd Movie) .....	86
<b>Saving the Settings (Memory) .....</b>	<b>87</b>
Saving the Menu Items (Memory) .....	87
<b>Playback / Erasing .....</b>	<b>89</b>
<b>Playing Back Images and Sound.....</b>	<b>89</b>
Playing Back Still Pictures .....	89
Zoom Display.....	89
Adding a Voice Memo .....	90
Playing Back Movie Pictures .....	91
Playing Back Sound .....	92
Playing back Shooting Information (Playback Mode) .....	93
Nine-image Display .....	94
Slideshow .....	95
<b>Erasing Images .....</b>	<b>96</b>
Erasing a Single Image or Sound.....	96

Erasing All Images.....	98
Protecting Images from Deletion (Protect) .....	99
<b>Viewing Images on a TV .....</b>	<b>100</b>
<b>Setting the Printing Service (DPOF).....</b>	<b>101</b>
Printing Single Image .....	101
Printing All Images.....	103
<b>Printing Directly from the Camera Connected to a Printer .....</b>	<b>104</b>
Connecting the camera to the printer .....	104
Printing one image at a time .....	105
Printing using the printing service settings .....	105
Disconnecting the camera from the printer.....	106
<b>Editing / Settings .....</b>	<b>107</b>
<b>Editing Images .....</b>	<b>107</b>
Changing the Image Size .....	107
Trimming Images .....	109
Using Digital Filters to Edit Images.....	110
<b>Camera Settings.....</b>	<b>112</b>
Formatting a SD Memory Card / MultiMediaCard .....	112
Changing the Sound Settings.....	113
Setting the Date Style.....	115
Changing the Date / Time.....	116
Setting the World Time .....	116
Changing the Start-up Screen .....	118
Changing the Display Language .....	119
Changing the Video Output Format.....	119
LCD Power Saving (Sleep Timeout).....	120
Setting Auto Power Off .....	120
Setting the Quick Delete Function .....	121
Setting the Quick Zoom Function .....	121
Registering Functions.....	122
Adjusting the Focus Limit .....	124
Resetting to Default Settings (Reset) .....	125
<b>Setting the Alarm .....</b>	<b>126</b>
Checking the Alarm .....	126
Setting the Alarm .....	126
Turning the Alarm Off .....	127
<b>Appendix .....</b>	<b>128</b>
<b>List of City Names.....</b>	<b>128</b>
<b>List of Menu Default Settings .....</b>	<b>129</b>
<b>Adjustable [Rec.Mode] Menu Items by Capture Mode .....</b>	<b>131</b>
<b>Messages .....</b>	<b>132</b>
<b>Troubleshooting.....</b>	<b>134</b>
<b>Main Specifications .....</b>	<b>136</b>
<b>Optional Accessories .....</b>	<b>138</b>
<b>WARRANTY POLICY.....</b>	<b>139</b>



# Contents of the operating manual

This Operating manual contains the following chapters.

## 1 Getting Started

This chapter explains what you need to do after purchasing the camera before you start taking pictures. Be sure to read it and follow the instructions.

## 2 Quick Start

This chapter explains the simplest way to take pictures and play back images. Use it if you want to start taking pictures straightaway. It also tells you how to use the SD Memory Card / MultiMediaCard.

## 3 Common Operations

This chapter explains common operations such as the functions of the mode dial and buttons, and how to use the menus. For more details, refer to the respective [Taking Pictures], [Playback/Erasing] and [Editing/Settings] chapters.

## 4 Taking Pictures

This chapter explains the various ways of capturing images and how to set the relevant functions.

## 5 Playback / Erasing

This chapter explains how to play back images on the camera or on a TV and how to delete images.





## 6 Editing / Settings

This chapter explains how to edit images and set the camera-related functions.

## 7 Appendix

This tells you about the messages displayed on the LCD monitor and what to do in the event of trouble.

The meanings of the symbols used in this Operating manual are explained below.

	indicates the reference page number for an explanation of the related operation.
	indicates information that is useful to know.
	indicates precautions to be taken when operating the camera.
	The icons above the title show the Capture modes, that can activate the function.

1

2

3

4

5

6

7

## Checking the Contents of the Package



Camera  
Optio 555

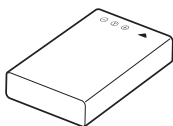

Lithium-ion battery D-LI7  
Rechargeable (\*)

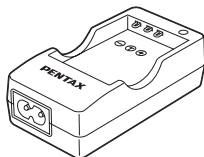

Battery charger  
D-BC7 (\*)

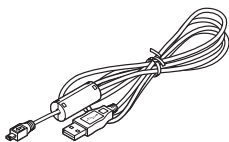

USB cable  
I-USB7 (\*)

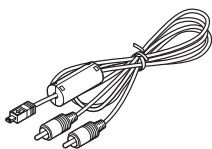

AV cable  
I-AVC7 (\*)

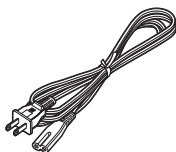

AC plug cord  
D-CO2 (\*)

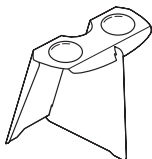

3D Image Viewer  
O-3DV1

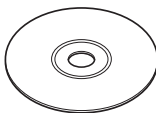

Software (CD-ROM)  
S-SW13

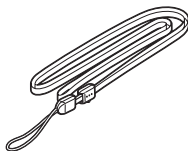

Strap  
O-ST5 (\*)



Operating Manual  
(this Manual)



Operating Manual  
(PC Connection Manual)

\* **About items marked with (\*)**

\* items marked with (\*) are also available as optional accessories. For other optional accessories, refer to the list on page 138.

\* **Type of AC plug cord**

D-CO2A Australia / D-CO2B United Kingdom / D-CO2E Europe / D-CO2H Hong Kong / D-CO2J Japan / D-CO2K Korea / D-CO2U North America, Canada

# Names of Parts

## Front

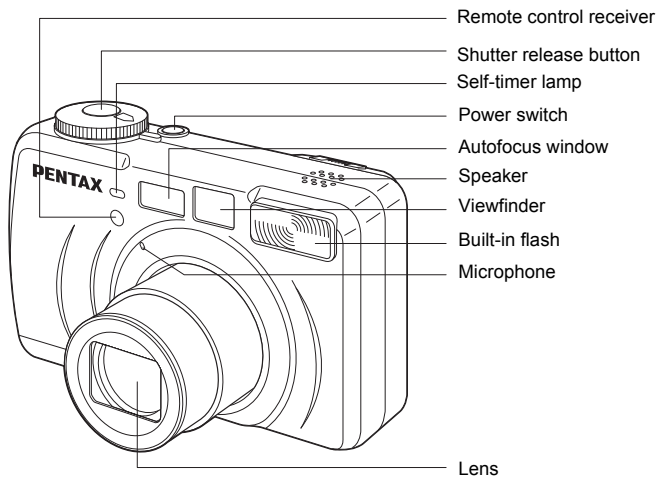

## Back

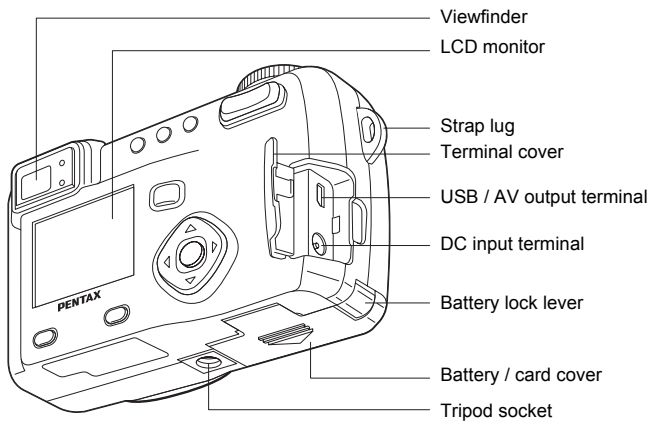

# Names of Operating Parts

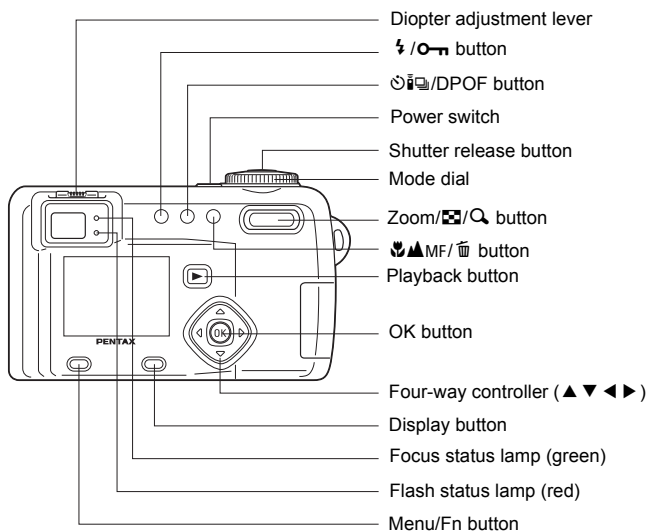

## Guide indications

A guide to available button operation is displayed on the LCD monitor during operation. The buttons are indicated as shown below.

Four-way controller (▲)	▲	Zoom /  /  button (Only for digital zoom and magnified playback)	
Four-way controller (▼)	▼	DISPLAY button	
Four-way controller (◀)	◀	DPOF button	
Four-way controller (▶)	▶	button	
Menu/Fn button		button	
Shutter release button		OK button	

## Attaching the Strap

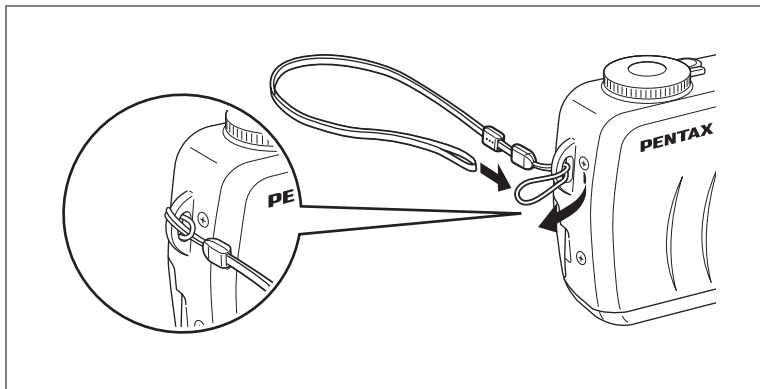

Pass the narrow end of the strap through the strap lug and pass the other end through the loop.

# Powering the Camera

1

Getting Started

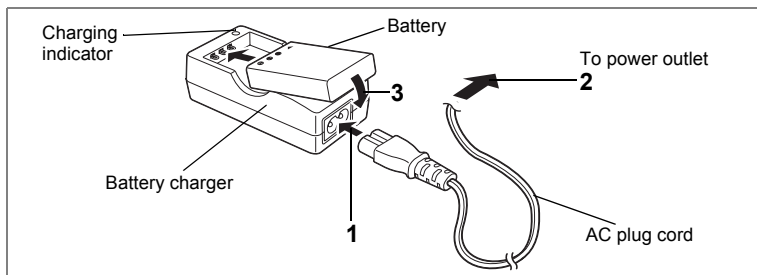

## Charging the Battery

When using the camera for the first time or when the [Battery depleted.] message is displayed, charge the battery.

- 1 Connect the AC plug cord to the battery charger.**
- 2 Plug the AC plug cord into the power outlet.**
- 3 Place the battery in the charger with the label facing up.**  
The charging indicator lights red while the battery is charging and changes to green when charging is completed.
- 4 When charging is completed, remove the battery from the battery charger.**



- The time required for full charge is about 180 minutes maximum. The appropriate ambient temperature range for charging the battery is 0°C-40°C (32°F to 104°F).
- The charging time may vary depending on the ambient temperature and charging conditions.
- When the battery reaches the end of its service life, the time that the camera can be operated becomes shorter even when the battery is fully charged. In this event, replace the battery.



- Always charge the battery after purchasing or when it has not been used for a long time.
- Use the Battery charger D-BC7 to charge the rechargeable Lithium-ion battery D-LI7 only as the charger may overheat or be damaged.
- If the battery is inserted correctly but the charging indicator fails to light, the battery may be faulty. Replace with a new battery.

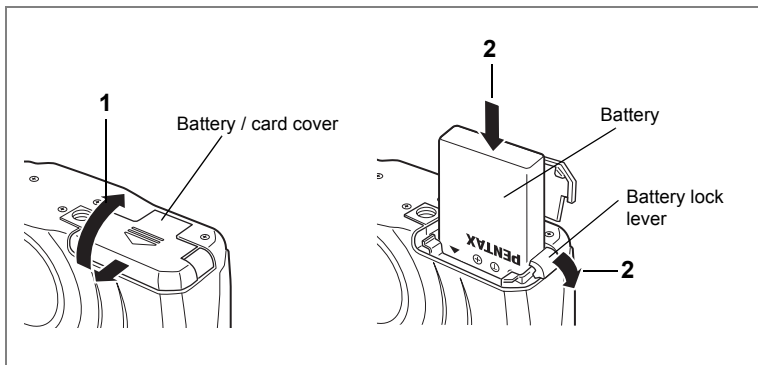

## Installing the Battery

Install the battery provided. When using the camera for the first time, charge the battery before installing.

- 1 Slide the battery / card cover in the direction indicated by the arrow to open the battery / card cover.**
- 2 Insert the battery with the label facing towards the lens while using the side of the battery to press the battery lock lever in the direction indicated by the arrow.**  
Check that it is firmly secured by the battery lock lever when you have inserted the battery.
- 3 Close the battery cover.**

To remove the battery, release the battery by using your finger to press the battery lock lever in the same direction as when you inserted the battery, and pull the battery out.



Use of the AC adapter D-AC7 (optional) is recommended when you intend to use the camera continuously for a long period. (☞ p.15)



- The rechargeable lithium-ion battery D-LI7 is exclusively for powering this camera. If you use any other battery the camera may be damaged or malfunction.
- Do not remove the battery when the camera is turned on.
- If you do not intend to use the camera for a long time, remove the battery.
- If the camera is left without the battery for a long time, the date setting will be reset.
- Insert the battery correctly. If the battery is incorrectly oriented, it may cause malfunction.

## ● Approximate Operating Time (when the D-LI7 battery is fully charged)

Number of recordable images: Approx. 400 (when 50% shooting uses flash, LCD monitor ON)

Playback time : Approx. 210 min.



The description above is based on Pentax measuring conditions and may vary depending on capture mode and shooting conditions.



- Generally, battery performance is temporarily deteriorated as temperature decreases. When the camera is used in a cold environment, keep this product warm by holding it in some protection against cold or inside the clothes.
- Battery performance once deteriorated due to low temperature will be recovered when the batteries are returned to room temperature.

## ● Battery Level Indicator

You can check the battery level by the symbol displayed on the LCD monitor.

(lit green)	: Adequate power remains.
↓	
(lit green)	: Battery is running low.
↓	
(lit yellow)	: Battery is running very low.
↓	
(lit red)	: Battery is exhausted.
↓	
[Battery depleted.]	: After the message is displayed, the camera will turn off.



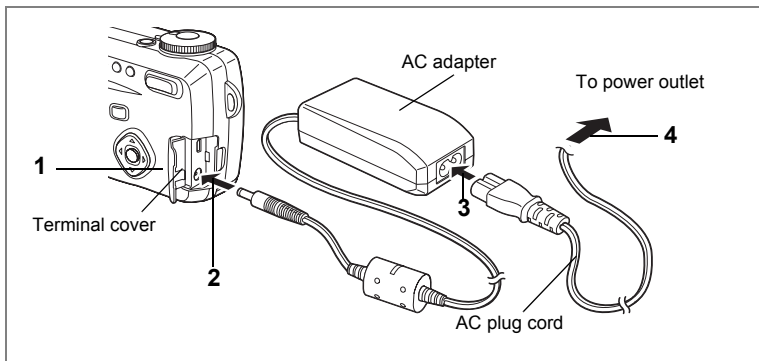

## Using the AC Adapter (optional)

Use of the AC adapter D-AC7 (optional) is recommended if you intend to use the LCD monitor for a long time or connect the camera to a PC or printer.

- 1 Make sure that the camera is turned off and opening the terminal cover.**
- 2 Connect the DC terminal on the AC adapter to the DC input terminal on the camera.**
- 3 Connect the AC plug cord to the AC adapter.**
- 4 Plug the AC plug cord into the power outlet.**



- Make sure that the camera is turned off when connecting or disconnecting the AC adapter.
- Make sure that the AC plug cord and connecting cord are inserted securely. If the cord becomes disconnected while you are taking pictures, the data may be lost.
- Be sure to read the operating manual accompanying the AC adapter when using the AC adapter D-AC7.

# Installing the SD Memory Card / MultiMediaCard

1

Getting Started

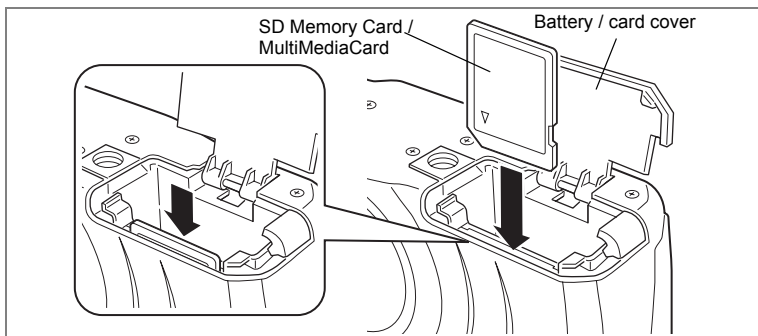

MultiMediaCards and the SD Memory Card can be used with this camera. Captured images or recorded voice are recorded on the SD Memory Card / MultiMediaCard. Make sure that the camera is turned off before inserting or removing the SD Memory Card / MultiMediaCard.

## 1 Open the battery / card cover.

Follow the steps described on p.15 to open the cover.

## 2 Rotate the card with the surface of the card having the ▲ symbol facing towards the lens and with the pin-connector edge of the card towards the slot and insert fully until it clicks.

If the card is not inserted correctly, images and voice memos may not be recorded properly.

## 3 Close the battery / card cover.

To remove the card, eject the card by pressing it in the direction indicated by the arrow, and pull it out.

### ● Approximate Number of Recordable Images and Recorded pixels / Quality levels

Quality levels Recorded pixels	Quality levels				Movie images (320 × 240)	voice recording
	TIFF	Best (★★★)	Better (★★)	Good (★)		
2592 × 1944	0	Approx. 4	Approx. 8	Approx. 14	Approx. 40sec.	Approx. 30min.
2048 × 1536	–	Approx. 7	Approx. 12	Approx. 18		
1600 × 1200	–	Approx. 11	Approx. 20	Approx. 27		
1024 × 768	–	Approx. 25	Approx. 45	Approx. 56		
640 × 480	–	Approx. 53	Approx. 82	Approx. 100		

- The table indicates the number of images when using a 16MB SD Memory Card.
- The table is based on standard shooting conditions specified by PENTAX and may vary depending on the subject, shooting conditions, Capture mode, SD Memory Card, etc.
- As TIFF data is uncompressed, it cannot be stored on a 16MB SD Memory Card/ MultiMediaCard. Use a Card with a capacity of 32MB or more.

## ● Precautions When Using a SD Memory Card / MultiMediaCard

- Make sure that the camera is turned off before opening the battery / card cover.
- The SD Memory Card is equipped with a write-protect switch. Setting the switch to [LOCK] protects the existing data by prohibiting recording of new data, deletion of existing data or formatting of the card.
- The SD Memory Card / MultiMediaCard formatted by the other equipment than this camera cannot be used for PC, etc.  
Formatting must be done by this camera.
- Care should be taken if you remove the SD Memory Card / MultiMediaCard immediately after using the camera, as the card may be hot.
- Do not remove the SD Memory Card / MultiMediaCard or turn the camera off while data is being recorded on the card or transferred to PC using USB cable as this may cause the data to be lost or the card to be damaged.
- Do not bend the SD Memory Card / MultiMediaCard or subject it to violent impact.
- Keep it away from water and store away from high temperature.
- Be sure to format unused SD Memory Card / MultiMediaCard or SD Memory Card / multimedia cards that have been used on another camera. Refer to "Formatting a SD Memory Card / MultiMediaCard" (p.112) for instructions on formatting.
- Never remove the SD Memory Card / MultiMediaCard during formatting as this may cause the card to be damaged and become unusable.
- The data on the SD Memory Card / MultiMediaCard may be erased in the following circumstances. Pentax does not accept any liability for data that is erased.
  - when the SD Memory Card / MultiMediaCard is mishandled by the user.
  - when the SD Memory Card / MultiMediaCard is exposed to static electricity or electrical interference.
  - when the card has not been used for a long time.
  - when the card is ejected, the AC adapter is disconnected or the battery is removed while the data on the card is being accessed.
- The SD Memory Card / MultiMediaCard has a limited service life. If it is not used for a long time, the data on the card may become unreadable. Be sure to make a backup of important data on a PC.
- Avoid using or storing the card where it may be exposed to static electricity or electrical interference.
- Avoid using or storing the card in direct sunlight or where it may be exposed to rapid changes in temperature or to condensation.

Write-protect switch

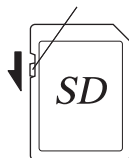

# Turning the Camera On and Off

1

Getting Started

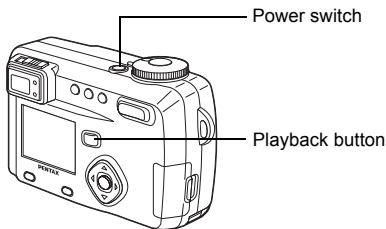

## 1 Press the power switch.



The camera will turn on.

When the camera is turned on, the lens cover opens and the lens extends.

Press the power switch again to turn the camera off.

## Card Check

It automatically performs a card check when the camera is turned on.  appears on the LCD monitor if no SD Memory Card / MultiMediaCard has been inserted.

And when the write-protect switch is set to LOCK,  will be displayed instead of , and the images or sound cannot be recorded.

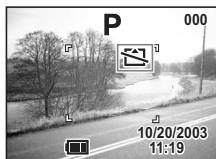

## Play back Only Mode

Press the power switch while pressing the playback button, the playback only mode will be activated.

- If the camera is turned on by the playback only mode, the lens cannot be popped up.
- Turn off the camera and then turn it again to change from the playback only mode to shooting mode.

Playing Back Still Pictures  p.26.

# Adjusting the Viewfinder

1

Getting Started

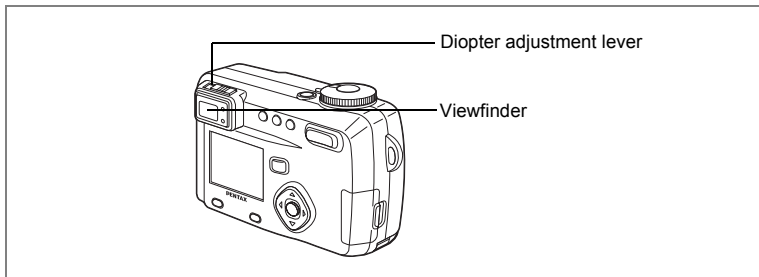

You can adjust the diopter in the range of  $-3 \text{ m}^{-1}$  to  $+1 \text{ m}^{-1}$  (per meter) if the subject through the viewfinder are hard to see.

- 1 Aim the camera at the bright subject. While looking through the viewfinder move the diopter adjustment lever to the left or right until the subject appears in the sharpest focus.**

For easy adjustment, point the camera at a subject with clearly defined outlines.

# Initial Settings

1

Getting Started

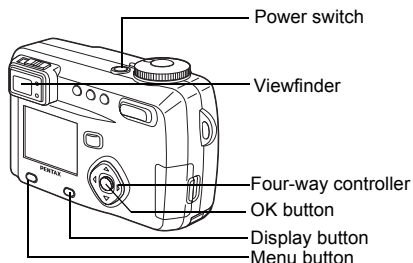

If the initial settings screen appears when you turn the camera on, follow the procedure below to set the display language, Home Town, DST, and current date and time. If the date and time that appear at the bottom right of the LCD monitor when you turn the camera on for the first time is not the current time, follow the instructions for “Setting the Date and Time” (p.22) to set the correct date and time.

## Setting the Display Language

You can choose the language in which the menus, error messages, etc. are displayed from the following: English, French, German, Spanish, Italian, Japanese, Chinese and Russian.

- 1 Turn the camera on.**
- 2 Use the four-way controller (◀▶) to select the display language.**

The default setting is English.

- 3 Press the four-way controller (▼).**

The screen for setting the city will be displayed.

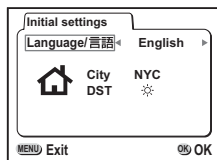

You can change the setting after it has been made. Refer to “Changing the Display Language” (p.119).

## Setting the Home Town

You can choose the city (Home Town) in which you will use the camera.

**1 Press the four-way controller (◀▶) to select the desired city (Home Town).**

**2 Press the four-way controller (▼).**

The screen for setting the D.S.T will be displayed.

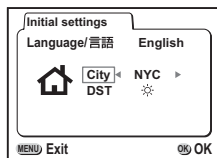

- See p.128 for the list of cities and corresponding code names.
- You can change the setting after it has been made. Refer to “Setting the World Time” (p.116).

## Setting the D.S.T. Mode

You can choose whether or not to display the ☼ (Daylight Saving Time) mode.

**1 Use the four-way controller (◀▶) to select ☼ or ☼.**

The default setting is ☼ (Off).

**2 Press the OK button.**

The screen for setting the Data and Time will be displayed.

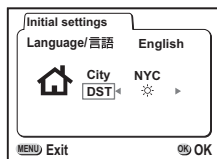

You can change the setting after it has been made. Refer to “Setting the World Time” (p.116).

# Setting the Date and Time

Set the current date and time.

**1** Use the four-way controller (▲▼) to change the month.

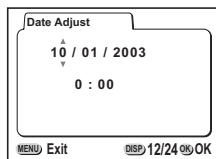

**2** Press the four-way controller (▶).  
▲ and ▼ will be displayed above and below the month.

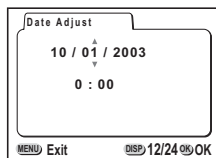

**3** Use the four-way controller (▲▼) to change the day and press the four-way controller (▶).  
▲ and ▼ will be displayed above and below the day.

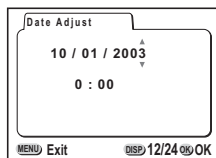

**4** Repeat Step 3 to change the [year] [hour] and [minutes].

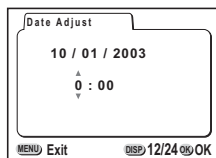

**5** Use the Display button to select the 12-hour or 24-hour display format.

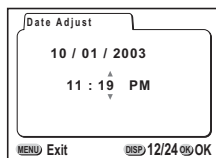



## 6 When you have finished the settings, press the OK button when the clock reaches 00 seconds.

The camera is ready to take a picture.

Press the OK button again after pressing the OK button when the clock reaches 00 seconds to return to Capture mode when you set date and time except the initial settings.



- For an accurate time setting, when you have finished the settings, press the OK button when the clock reaches 00 seconds.
- You can cancel the settings operation and switch to Capture mode by pressing the MENU / Fn button when the initial settings screen is displayed. If this is done, the initial settings screen will be displayed next time you turn the camera on.
- You can change the settings after they have been made. Refer to "Changing the Date / Time" (p.116).

## Taking Still Pictures

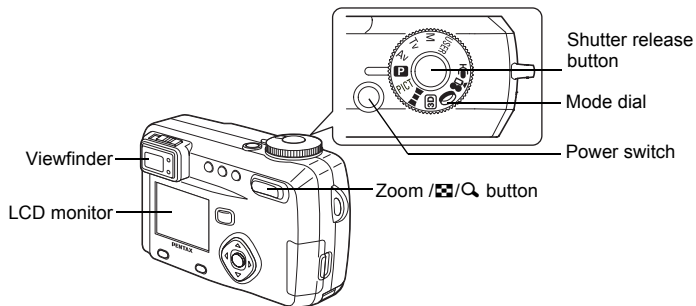

For the simplest procedure to take still pictures.  
The flash fires automatically depending on the light conditions.

- 1 Press the power switch.**
- The camera will turn on.
- 2 Set the mode dial to **P**.**
- 3 Confirm the subject and shooting information on the LCD monitor.**

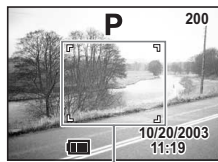

Focus Area

The focus area in the middle of the LCD monitor indicates the zone of automatic focusing. You can change the size of the subject by pressing the Zoom button.

- ⬆ : makes the subject bigger.
- ⬆⬆⬆ : makes the subject smaller.

You can check the size of the subject by looking through the viewfinder.



As there is no focus area in the viewfinder, be sure to check the focusing area on the LCD monitor.

## 4 Press the shutter release button.

The image will be displayed on the LCD monitor for 2 seconds (Instant Review) and recorded on the SD Memory Card / MultiMediaCard. (The green and red lamps on the right of the viewfinder blink alternately while the image is being recorded on the SD Memory Card / MultiMediaCard.)

### Using the Shutter Release Button

The shutter release button works in a two-step action.

#### ● Press halfway

The focus and exposure are locked when the shutter release button is pressed lightly (halfway).

They remain locked while the button is pressed halfway, and the shutter speed and aperture are displayed on the LCD monitor.

You can find the following information on the LCD monitor, the status lamp and the flash lamp.

#### 1 Autofocus area

If the subject is in focus, the frame will light green. If the subject is out of focus, the frame will not appear.

#### 2 Focus status lamp & Flash status lamp

status	Focus status lamp (green)	Flash status lamp (red)
lit	Subject is in focus	Flash is charged
blink	Subject is out of focus	Flash is charging

You cannot take a picture while the flash is charging. Use manual focus to take the picture when the image is not focused.

Focus manually.  p.41

#### ● Pressed down fully

The picture is taken.

### Instant Review

The Instant Review default setting is 2 seconds. During this time you can delete the image by pressing the  button (The [Delete] menu will be displayed.), and selecting [Delete], and then pressing the OK button. To start recording a voice memo, press the OK button during Instant Review. Press the OK button again to stop recording.

Setting the Instant Review Time  p.50

## Playing Back Still Pictures

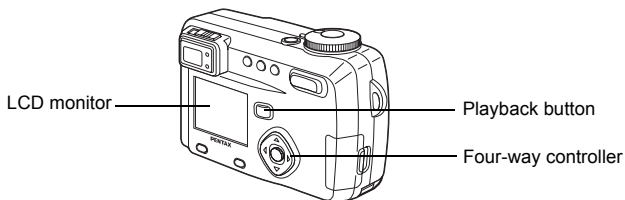

### Playing Back Images

You can display the still picture.

#### 1 Press the **Playback** button after taking a picture.

The image taken will be displayed on the LCD monitor.

#### To rotate the displayed image

The image will be rotated 90° clockwise each time your press the four-way controller (▼)

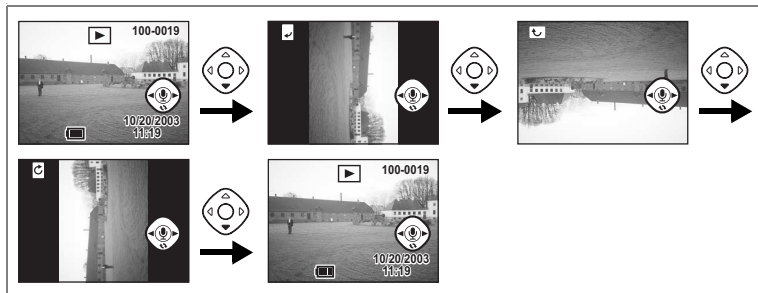

- You cannot rotate movie pictures.
- You cannot rotate images while playing back a voice memo.

## Playing Back Previous or Next Images

Still images can be played back one at a time, proceeding either forward or backward.

### 1 Press the Playback button after taking a picture.

An image will be displayed on the LCD monitor.

### 2 Press the four-way controller (◀▶).



 displays the previous image.

 displays the next image.

## Erasing the image displayed on the LCD monitor

While the image is displayed, you can erase it by pressing the  button (The Delete screen will be displayed.), press the four-way controller (▲) to select [Delete], and then pressing the OK button. Press the Playback button or press the shutter release button halfway to return to shooting status.



- The camera turns on in Playback Only mode when you turn the camera on while pressing the Playback button. As the lens does not extend in Playback Only mode, this feature is useful when you want to pass the camera to someone and show them the picture you have just taken. Turn the camera off and then turn it on again to switch to the Capture mode.
- You can enlarge the image displayed on the LCD monitor by pressing the Zoom /  /  button.
- When the screen is changed to the playback screen, the image with the largest file number will be displayed first.
- In the case of movie pictures, the first frame will be displayed.
- If there are no images stored, the [No image & sound] message will be displayed.

Zoom Display  p.89  
Adding a Voice Memo  p.90

## How to View the Recorded Images

Images taken with the Optio 555 camera are recorded on the SD Memory Card / MultiMediaCard. You can view the images recorded on the card on the camera itself, transfer them to your PC and print them out.



### Viewing images on the camera

One of the advantages of a digital camera is that it enables you to view your pictures immediately after you have taken them. You can check the composition and focus and take the picture again if you are not satisfied.

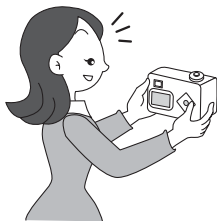

Playing Back Still Pictures  p.89

### Viewing images on a TV

If you want to show your pictures to friends, you can display them on your TV monitor. Connect the camera to the TV with the AV cable to view images on your TV.

Viewing Images on a TV  p.100



## Viewing images on a PC

You can view recorded images and edit them on the PC just by connecting the camera to the PC with the USB cable and downloading the images (you need to install the USB driver if you are using Windows 98/98SE). Or you can remove the SD Memory Card / MultiMediaCard from the camera and transfer the data to your PC using a card reader. If you use a laptop computer, you can transfer the image data by fitting the SD Memory Card / MultiMediaCard into the card adapter and inserting the card adapter into the card slot. If you are using a printer that is compatible with PictBridge, you can print pictures by using a USB cable to connect the camera directly to a printer.

Printing by directly connecting the camera to the printer  p.104

Process from taking pictures to printing  (PC connection manual) p.4-5



## Printing images by a printing service

Prints of images recorded on the SD Memory Card / MultiMediaCard can be ordered in the same way as with conventional photographs by taking the SD Memory Card / MultiMediaCard to a store that performs printing. The number of prints can be specified and dates can be included in the prints if DPOF (Digital Print Order Format) is set before taking the SD Memory Card / MultiMediaCard to a store that performs DPOF printing.

Setting the Printing Service  p.101



# Changing the Mode

Capture mode is for taking pictures and voice recording.

Playback mode is for playing back or erasing images and sound.

## Switching Between Capture Mode and Playback Mode

- Press the Playback button to change from Capture mode to Playback mode.
- Press the Playback button or the shutter release button halfway to change from Playback mode to Capture mode.

## Selecting the Capture Mode

### 1 Turn the mode dial so that the mark is on USER M Tv Av

**P** PICT ■■■ 3D 0 🎥 or 🎙.

<b>USER</b>	User mode	The functions are set in advance and the settings are enabled whenever the camera is turned on.	p.58
<b>M</b>	Manual exposure	You can set the shutter speed and aperture manually.	p.56
<b>Tv</b>	Shutter-priority	You can set the shutter speed manually, and the aperture is set automatically.	p.55
<b>Av</b>	Aperture-priority	You can set the aperture manually, and the shutter speed is set automatically.	p.54
<b>P</b>	Program	The shutter speed and aperture are set automatically when taking still pictures.	p.53
<b>PICT</b>	Picture	You can select a Capture mode from 9 modes according to the scene you are taking.	p.60
■■■	Panorama	This mode is for taking panorama pictures.	p.62
3D	3D	This mode is for taking 3D pictures.	p.64
0	Digital filter	This mode is for taking pictures using a variety of filters such as red, blue and green.	p.70
🎥	Movie picture	This mode is for taking moving images. (Sound can also be recorded.)	p.72
🎙	Voice recording	This mode is for recording sound.	p.69



# Using the Button Functions

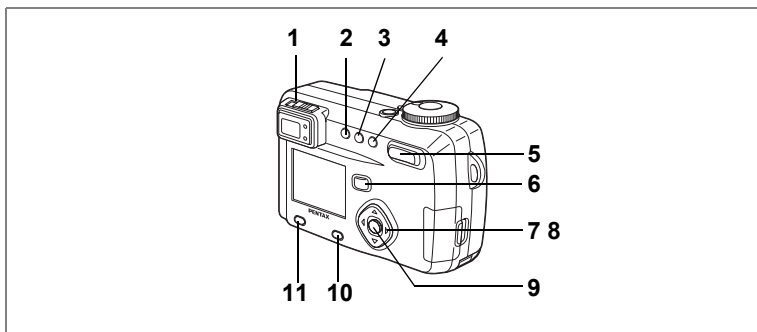

## Capture Mode

### 1 Diopter adjustment lever

Adjusts the viewfinder for optimum clarity. (☞ p.19)

### 2 button

Changes the flash mode. (☞ p.42)

### 3 button

Changes the Capture mode as follows.



Using the self-timer (☞ p.77)

Using the remote control unit (☞ p.78)

Continuous shooting (☞ p.79)

Multiple exposure shooting (☞ p.82)

Interval shooting (☞ p.80)

\*When the Capture mode is set to    continuous shooting, multiple exposure shooting and Interval shooting mode will be skipped.

### 4 MF button

Changes the focus mode. (☞ p.40)

### 5 Zoom button

Changes the size of the subject. (☞ p.74)

## 6 Playback button

Switches to Playback mode. (☞ p.33)

## 7 Four-way controller (◀▶)

Changes the EV compensation in modes other than **M** and **☺**. (☞ p.74)

Changes the shutter speed in **M** mode. (☞ p.56)

## 8 Four-way controller (▲▼)

Adjusts the focus in **MF** mode. (☞ p.41)

Sets the aperture value in **M** and **Av** mode. (☞ p.56, 54)

Sets the shutter speed in **Tv** mode. (☞ p.55)

Selects the type of filter in **☺** mode. (☞ p.70)

Selects Picture mode in **PICT** mode. (☞ p.60)

## 9 OK button

Sets the selected menu item. (☞ p.34)

When pressed in **MF** mode, the function on the four-way controller (▲▼) reverts to the function set by the mode dial.

## 10 Display button

Changes the information displayed on the LCD monitor. (☞ p.38)

## 11 Menu / Fn button

Displays the active menus in Capture mode and retrieves the functions registered on the four-way controller. (☞ p.34, 123)

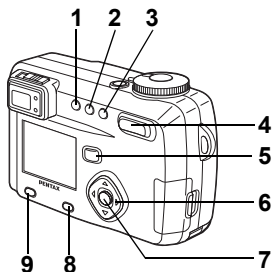

## Playback Mode

- 1** **Lock button**  
 Protects the image from erasure. (☞ p.99)
- 2** **DPOF button**  
 Sets the DPOF data for printing pictures. (☞ p.101)
- 3** **Trash button**  
 Deletes the image. (☞ p.96)
- 4** **Zoom [9]/[Q] button**  
 [9] displays nine images at once. (☞ p.94)  
 Press [Q] in normal mode to change the size of the Zoom Display image, displayed on the LCD monitor. (☞ p.89)
- 5** **Playback button** (☞ p.30)  
 Switches to Capture mode.
- 6** **Four-way controller (◀▶)**  
 Displays images one by one. (☞ p.27)
- 7** **OK button**  
 Saves the function selected by the menu item. (☞ p.34)  
 When pressed in Normal Playback mode, the voice memo starts, and when pressed again, the voice memo stops. (☞ p.90)  
 When pressed in Zoom Display or Nine-image Display mode, changes to Normal Playback mode. (☞ p.89, 94)
- 8** **Display button**  
 Changes the information displayed on the LCD monitor. (☞ p.93)
- 9** **Menu / Fn button**  
 Displays the active menus in Playback mode. (☞ p.34)

# Using the Menu

The menus are displayed on the LCD monitor when you press the Menu / Fn button. You can set functions, save the settings and change the camera settings on these menus.

## How to Set the Menu

When you are making settings from a menu, a guide to operation is displayed on the LCD monitor.

3

Common Operations

### 1 Press the Menu / Fn button.

The menu screen will be displayed. The selected area will be underlined in green.

### 2 Press the four-way controller (◀▶).

Use the four-way controller (◀▶) to select the menu screen.

### 3 Use the four-way controller (▲▼) to select an item.

Use the four-way controller (▲▼) to move the frame up or down.

### 4 Use the four-way controller (◀▶) to change the setting.

### 4' If there is a select screen, use the four-way controller (▶) to move to the select screen.

### 5 Press the OK button.

The settings will be saved and the screen will return to capture or playback status.

If the menu screen is not exited, press the OK button again.

- If you press any buttons except the OK button before press the OK button and leave the menu screen, any changes to setting will not be saved.
- Even if you press the OK button and leave the menu screen, if you remove the battery before turning off the camera or do not otherwise turn off the camera correctly, any changes to setting will not be saved.

## Example of menu operation

### 1 Menu / Fn button

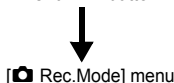

[ Rec. Mode] menu

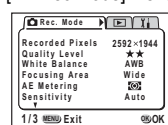

2



[ Playback] menu



2



[ Set-up] menu



3

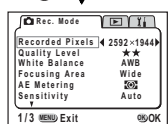

3

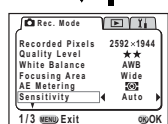

4

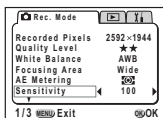

3

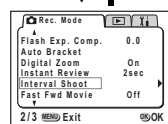

4'

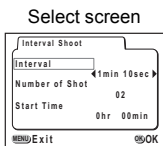

Select screen

3



To the next screen



- If you press the shutter release button halfway and move the camera to Capture mode, any changes to the setting will not be saved.
- The [ Rec. Mode] menu will be displayed and when you display the menu from Capture mode, the [ Playback] menu will be displayed when you display the menu from Playback mode.

3

## Menu List

Please refer to pages 141 to 143 for List of Menu Default settings and the adjustable [Rec. mode] menu items by Capture mode.

### ● [📷 Rec.Mode] Menu

Item	Description	Reference
Recorded Pixels	For selecting the size of recorded pixels.	p.43
Quality Level	For selecting the image compression rate.	p.44
White Balance	For adjusting the color balance according to lighting.	p.45
Focusing Area	For changing the Area of the autofocus.	p.47
AE Metering	For setting the metering method to determine the exposure.	p.48
Sensitivity	For setting the sensitivity.	p.49
Flash Exp. Comp.	For adjusts the brightness of the flash without changing the brightness of the background.	p.52
Auto Bracket	For setting the shooting conditions such as exposure, saturation and sharpness.	p.84
Digital Zoom	For taking digital zoom pictures.	p.75
Instant Review	For setting the instant review time.	p.50
Interval Shoot	For taking pictures specified interval of time.	p.80
Fast Fwd Movie	For delaying the frame rate when taking movie pictures (so that the movie appears speeded up when played back)	p.86
3D Mode	For taking 3D pictures.	p.64
Memory	For saving the shooting function settings when the camera is turned off.	p.87
Sharpness	For setting the sharpness.	p.50
Saturation	For setting the saturation.	p.51
Contrast	For setting the contrast.	p.51
USER	For setting the functions registered in User mode.	p.59

## ● [▶ Playback] Menu

Item	Description	Reference
Resize	For changing the size of images	p.107
Trimming	For trimming images	p.109
Digital Filter	Apply a red, blue, green, or other image filter to a captured image.	p.110
Alarm	For setting the alarm to ring at specified time	p.126
Slideshow	Recorded images are played successively.	p.95
PictBridge	For printing directly from a digital camera connected to a printer.	p.104

## ● [⚙️ Set-up] Menu

Item	Description	Reference
Format	For formatting the SD Memory Card / MultiMediaCard	p.112
Sound	For adjusting the beep sound when a button is pressed. For setting the button operation, start-up, shutter sounds and volume.	p.113
Date Style	For setting the date style	p.115
Date Adjust	For adjusting the date and time	p.116
World Time	For setting the world time	p.116
Language	For changing the language in which menus and messages are displayed	p.119
Start-up screen	For setting the Start-up screen when the camera is turned on	p.118
Video Out	For setting the video output format	p.119
Sleep Timeout	For setting the power saving function	p.120
Auto Power Off	For turning off the power automatically.	p.120
Quick Delete	When this option is turned on, the Delete screen is displayed with [Delete] or [All Images] selected.	p.121
Quick Zoom	For playing back images at the set size with the Zoom button pressed only once.	p.121
Fn Setting	For registering a function on the four-way controller.	p.122
Focus Limiter	For switching between limiting and not limiting lens movement during normal shooting and macro shooting.	p.124
Reset	For returning the camera settings to defaults	p.125

# Displaying Shooting Information (Capture Mode)

You can display information on the LCD monitor when shooting. The display mode can be changed by pressing the Display button.

## Display On

Shooting information is displayed.

- 1 Flash mode
- 2 Drive mode
- 3 Focus mode
- 4 Capture mode
- 5 AF area
- 6 Number of images can be taken
- 7 Date & time
- 8 Battery indicator

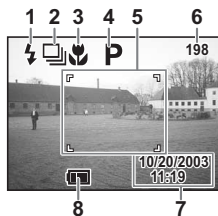

## Histogram Display

The brightness distribution of the image is displayed.

The x-axis shows the brightness (darkest at the left end and brightest at the right end) and the y-axis shows the pixel numbers.

- 1 Recorded pixels
  - 2 Quality level
  - 3 White balance
  - 4 AE metering
  - 5 Sensitivity
  - 6 Histogram
- The AF area will be displayed in the autofocus mode.

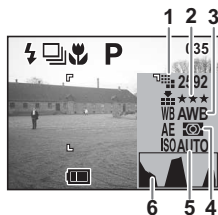

## Grid Display

The grid is displayed. This is useful for composing detailed pictures.

- The AF area will be displayed in the autofocus mode.



Go to next page



## Display Off

No shooting information is displayed.

- The AF area in autofocus mode is displayed.
- If any of the modes are changed such as Flash mode, the mode you have changed is displayed for a few seconds.







Display On

## LCD Monitor Off

Turn off the LCD monitor.

(The LCD monitor is not turned off in Playback mode.)



The LCD monitor does not turn off in     mode.

Saving the Display Mode  p.87

# Setting the Shooting Functions

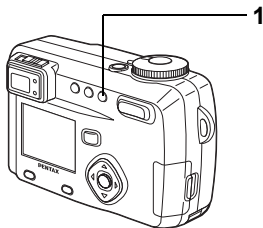

## 4 Selecting the Focus Mode

### ● Focus Mode

(No icon)	Autofocus mode	The camera is focused on the subject in the autofocus area when the shutter release button is pressed halfway. Use this mode when the distance to the subject is more than 60 cm (1.97 ft).
	Macro mode	This mode is used when the distance to the subject is approx. 15 cm – 65 cm (0.5 ft – 2.13 ft).
	Super macro mode	This mode is used when the distance to the subject is approximately 2 cm – 65 cm (0.8 inch – 2.13 ft).
	Infinity-landscape mode	This mode is used for taking distant objects.
MF	Manual focus mode	Adjust focus manually by the four-way controller (▲▼).
	Move focusing area	The position of the autofocus area is changed.

### 1 Press the ▲ or MF button in Capture mode.

The focus mode changes each time the button is pressed and the set focus mode is displayed on the LCD monitor.

The camera is ready to take the picture in the set focus mode.



- The default setting of the focus mode is [Autofocus mode].
- The focus is fixed and the focus mode cannot be selected in the movie picture mode (p.72).
- The zoom is fixed in the wide-angle position in Super Macro mode.
- The image may be overexposed or a dark area may appear at the bottom right of the picture when you use the flash in Macro mode.
- The flash does not discharge in Super macro mode.



If you take a picture while looking through the viewfinder when the focus mode is set on Macro or Super Macro, the range of the resulting picture will differ from what was seen in the viewfinder. Be sure to check the image on the LCD monitor.

## Manual Focus

The central portion of the picture is enlarged to full screen on the LCD monitor when the mode is set on MF and press the four-way controller (▲▼). Adjust the focus with the four-way controller while looking at the image on the monitor.



For distant focus



For closer focus

Press any buttons except the four-way controller (▲▼) or take a finger off from the four-way controller (▲▼), the screen returns to the normal display two seconds later after the focus is set.



- Keep pressing the four-way controller (▲▼) will move the focusing position rapidly.
- The central portion of picture is also enlarged in the Digital zoom mode except at maximum magnification.

Saving the Focus Mode p.87

## Hard-to-Autofocus Subjects

The autofocus mechanism is not all-powerful. Subjects which may not focus are listed below. In this situation, use focus lock, press the shutter release button halfway to focus on [ ] another subject that is equal distant from the camera, recompose the picture while holding the shutter release button halfway, and then take a picture.

- Extremely low-contrast subject such as a white wall in the focus points range.
- Subjects which don't reflect much light within the focus points range.
- Subjects that are moving extremely fast.
- Powerfully reflected light or strong backlight (subjects with extremely bright backgrounds).
- If vertical or horizontal line patterns appear within the focus points range.
- Multiple subjects in the foreground and background within the focus points range.

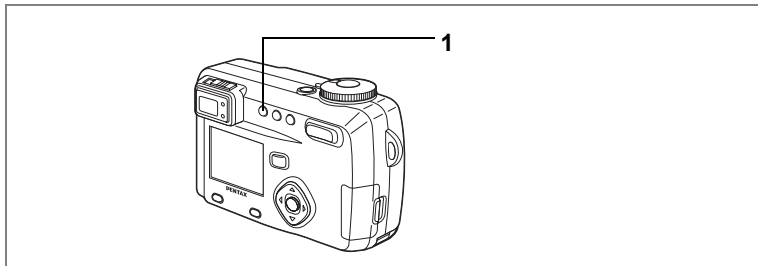

## Selecting the Flash Mode

(No icon)	Auto flash	The flash discharges automatically depending on the light conditions.
	Flash Off	The flash will not discharge.
	Flash On	The flash discharges.
	Auto flash + Red-eye Reduction	This mode reduces the phenomenon of red eyes caused by the light from the flash being reflected in the subject's eyes. The flash discharges automatically.
	Flash On + Red-eye Reduction	This mode reduces the phenomenon of red eyes caused by the light from the flash being reflected in the subject's eyes. The flash will discharge regardless of lighting conditions.



- The [Auto flash] and [Auto flash + Red-eye Reduction] modes cannot be selected when the Capture mode is set to **M**.
- The flash is off when the Capture mode is set to , continuous shooting, infinity-landscape, fireworks in picture mode or super macro mode.
- The flash discharges once before the main flash as supplementary light for AE metering.
- In [Auto flash + Red-eye Reduction] and [Flash On + Red-eye Reduction] modes, the flash discharges once to make the pupils of the subject's eyes smaller shortly before the main flash discharges to take the picture.

### 1 Press the button in Capture mode.

The flash mode changes each time the button is pressed and the icon is displayed on the LCD monitor.

The camera is ready to take the picture in the set flash mode.

Status of the Focus Status Lamp and Flash Status Lamp p.25  
Saving the Flash Mode p.87

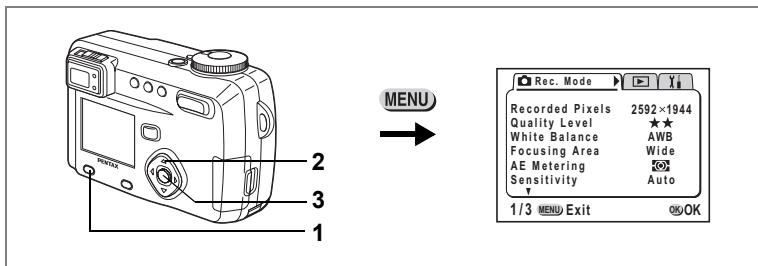

USER M Tv Av P PICT

## Selecting the Recorded Pixels

You can choose the number of recorded pixels from [2592 × 1944], [2048 × 1536], [1600 × 1200], [1024 × 768] and [640 × 480].

- 1** Select [Recorded Pixels] on the [Rec.Mode] menu.
- 2** Use the four-way controller (◀▶) to change the size.
- 3** Press the OK button.

The camera is ready to take the picture.

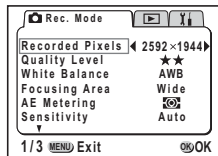

- The recorded pixels is fixed at 320 × 240 pixels in the movie picture mode.
- If you select a large size, the picture may appear distinct when it is printed out.
- Selecting a small size reduces the volume of data. This is useful for attaching images to E-mail or posting them on a website.

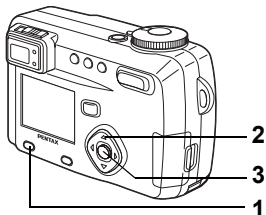

MENU

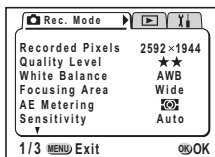

USER M Tv Av P PICT

## Selecting the Quality Levels

4

You can choose the image compression rate.

TIFF	TIFF	<ul style="list-style-type: none"> <li>Captures the image as uncompressed TIFF data. This is best for prints and images that will be manipulated on a PC.</li> </ul>
★★★	BEST	<ul style="list-style-type: none"> <li>The quality is better and there is a high volume of image data.</li> </ul>
★★	BETTER	<ul style="list-style-type: none"> <li>Standard level</li> </ul>
★	GOOD	<ul style="list-style-type: none"> <li>The quality is good and there is a low volume of image data.</li> </ul>

**1** Select [Quality Level] on the [Rec.Mode] menu.

**2** Use the four-way controller (◀▶) to change the image quality.

**3** Press the OK button.

The camera is ready to take the picture.

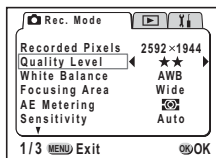

- The recorded pixels is 2592 × 1944 in the TIFF format.
- When the recorded pixels is set to other than 2592 × 1944, select the TIFF format and the recorded pixels changes to 2592 × 1944.

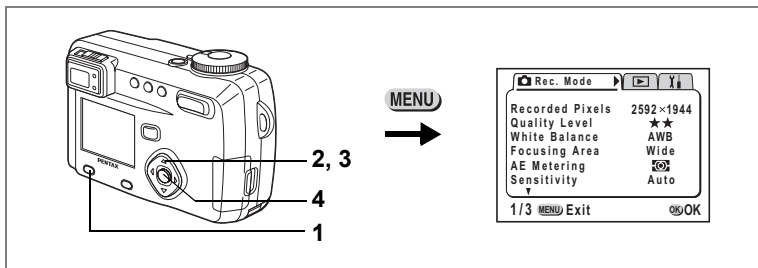

USER M Tv Av P [Battery Icon] [3D] [Zoom Icon] [Flash Icon]

## Adjusting the Color Balance according to Lighting (White Balance)

You can take pictures in natural colors by adjusting the white balance according to the light conditions at the time of shooting.

<b>AWB</b>	Automatic	The camera adjusts the white balance automatically.
	Daylight	Use this mode when taking pictures outside in sunlight.
	Shade	Use this mode when taking pictures outside in the shade.
	Tungsten Light	Use this mode when taking pictures under electric or other tungsten light.
	Fluorescent Light	Use this mode when taking pictures under fluorescent light. Choose the type of fluorescent light from W (white (4200°K)*), N (neutral white (5000°K)*) and D (daylight (6500°K)*).
	Manual	Use this mode when taking pictures by adjusting the white balance manually.

\* The color temperature (°K) is approximate and does not indicate the precise color.

- 1 Select [White Balance] on the [Rec.Mode] menu.**
- 2 Press the four-way controller (▶).**  
The white balance screen will be displayed.
- 3 Use the four-way controller (▲▼) to select the setting.**
- 4 Press the OK button twice.**

The camera is ready to take the picture.

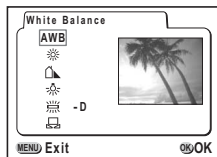

Saving the White Balance p.87

## Selecting the Type of Fluorescent Light

- 1 Select  on the White Balance screen.**
- 2 Use the four-way controller (◀▶) to choose “W”, “N” or “D”.**
- 3 Press the OK button twice.**

The camera is ready to take the picture.

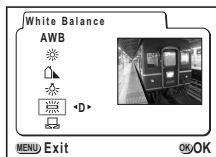

## Manual Setting

- 1 Select  (manual) on the white balance screen.**
- 2 Point your camera at a blank sheet of paper so that it fills the screen.**
- 3 Press the Display button.**

The white balance is automatically adjusted, [Complete] is displayed on the LCD monitor and the display returns to the menu screen.

- 4 Press the OK button.**

The camera is ready to take the picture.

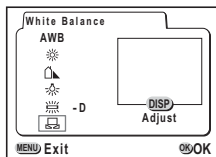



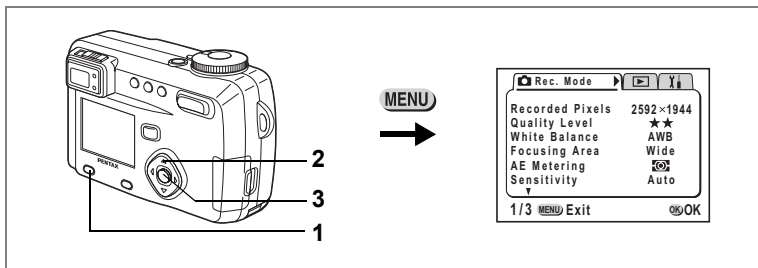

USER M Tv Av P PICT

## Changing the AF Area (Focusing Area)

You can change the angle of the autofocus area.

Wide	Normal range
Spot	The autofocus range becomes smaller.

- 1 Select [Focusing Area] on the [📷 Rec.Mode] menu.**
- 2 Use the four-way controller (◀▶) to change the setting.**
- 3 Press the OK button.**

The camera is ready to take the picture.

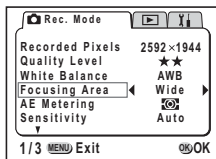

The AF area does not appear in the viewfinder. Always check the focusing area on the LCD monitor.

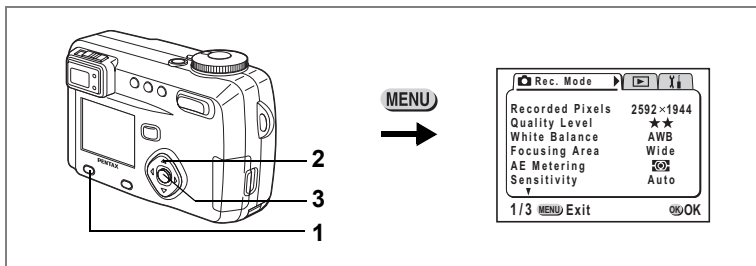

USER M Tv Av P PICT

## Setting the Light Metering Range to Determine the Exposure (AE Metering)

- 4 You can choose which part of the screen to use to measure the brightness and determine the exposure.

	Multi segment	The exposure is determined by the entire screen.
	Center-weighted	The exposure is determined mainly by the center of the screen.
	Spot	The exposure is determined by the small area in the center of the screen only.

- 1 Select [AE Metering] on the [Rec.Mode] menu.**
- 2 Use the four-way controller (◀▶) to change the metering mode.**
- 3 Press the OK button.**

The camera is ready to take the picture.

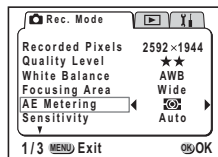

Saving the AE Metering Method p.87

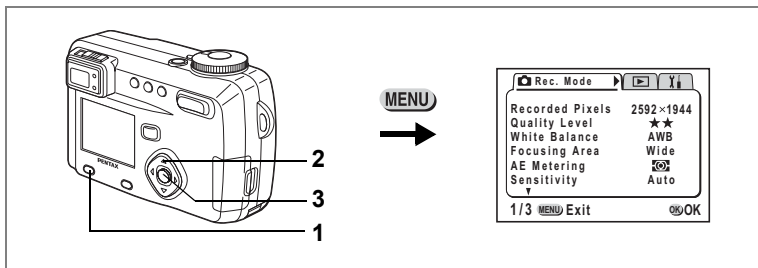

USER M Tv Av P PICT

## Setting the Sensitivity

You can select the sensitivity to suit the brightness of the surroundings.

### ● Sensitivity

Auto	The camera sets the speed automatically.
64	<ul style="list-style-type: none"> <li>As the lower sensitivity produces sharp images with little or no noise, but the shutter speed will be slower in low light conditions.</li> <li>As the higher sensitivity uses faster shutter speed in low light conditions to reduce camera shake.</li> </ul>
100	
200	
400	

**1** Select [Sensitivity] on the [Rec.Mode] menu.

**2** Use the four-way controller (◀▶) to change the Sensitivity.

**3** Press the OK button.

The camera is ready to take the picture.

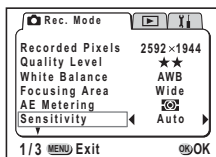

[Auto] cannot be selected in manual exposure mode.

Saving the Sensitivity p.87

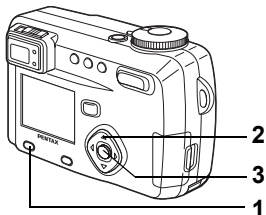

MENU

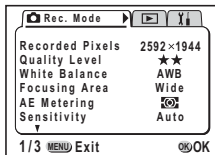

USER M Tv Av P PICT

## Setting the Instant Review time (Instant Review)

4

Taking Pictures

You can choose the Instant Review time from 0.5sec., 1sec., 2sec., 3sec., 4sec., 5sec. or OFF (no display).

- 1 Select [Instant Review] on the [Rec.Mode] menu.**
- 2 Use the four-way controller (◀▶) to change the display time.**
- 3 Press the OK button.**

The camera is ready to take the picture.

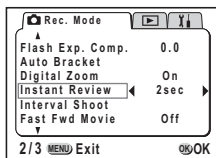

USER M Tv Av P PICT

## Setting the Image Sharpness (Sharpness)

You can choose whether you want the image to have sharp or soft outlines.

- 1 Select [Sharpness] on the [Rec.Mode] menu.**
- 2 Use the four-way controller (◀▶) to change the setting from [Normal] to [Hard (+)] or [Soft (-)].**
- 3 Press the OK button.**

The camera is ready to take the picture.

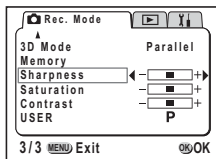

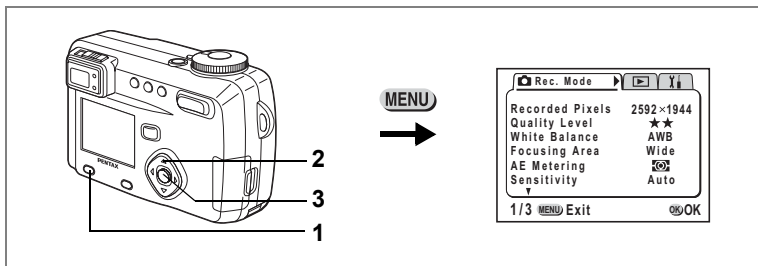

USER M Tv Av P [Battery Icon] [3D Icon] [Zoom Icon] [Camera Icon]

## Setting the Color Saturation (Saturation)

You can set the color saturation.

- 1 Select [Saturation] on the [Rec.Mode] menu.
- 2 Use the four-way controller (◀▶) to change the setting from [Normal] to [Hard (+)] or [Soft (-)].
- 3 Press the OK button.

The camera is ready to take the picture.

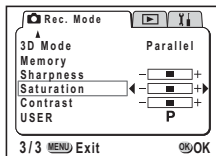

USER M Tv Av P [Battery Icon] [3D Icon] [Zoom Icon] [Camera Icon]

## Setting the Image Contrast (Contrast)

You can set the image contrast.

- 1 Select [Contrast] on the [Rec.Mode] menu.
- 2 Use the four-way controller (◀▶) to change the setting from [Normal] to [Hard (+)] or [Soft (-)].
- 3 Press the OK button.

The camera is ready to take the picture.

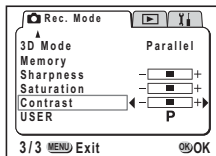

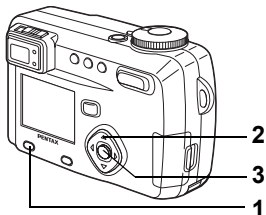

MENU

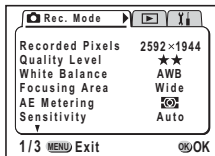

USER M Tv Av P ■■■ 3D 0

## Adjusting the Flash Output

4

You can adjust the output of the flash without changing the brightness of the background.

**1** Select [Flash Exp. Comp.] on the [Rec. Mode] menu.

**2** Use the four-way controller (◀▶) to select the compensation level.

- ◀ Reduces the brightness.
- ▶ Increases the brightness.

**3** Press the OK button.

The camera is ready to take the picture.

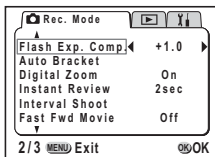

# Taking Pictures

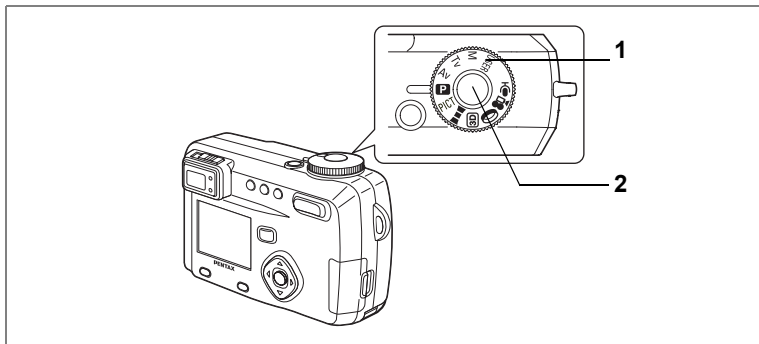

## Letting the Camera Set the Exposure (Program Mode)

The camera automatically sets the shutter speed and aperture for taking still pictures. However, you can select other functions such as the flash mode or continuous shooting mode.

- 1 Set the mode dial to **P**.**
- 2 Press the shutter release button.**

The picture will be taken.

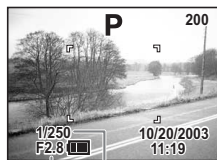

Aperture Shutter speed

Using the Shutter Release Button [↔](#) p.25  
Playing back images [↔](#) p.26

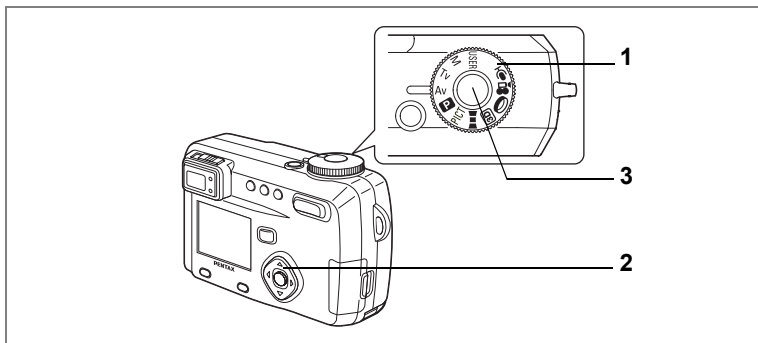

## Setting the Aperture Value (Aperture-Priority Mode)

In this mode the aperture value is set manually and the camera automatically sets the shutter speed.

- 1 Set the mode dial to Av.**
- 2 Use the four-way controller (▲▼) to change the aperture value.**
  - ▲ Makes the aperture larger.  
(Reduces the aperture value.)
  - ▼ Makes the aperture smaller.  
(Increases the aperture value.)
- 3 Press the shutter release button.**



Aperture value

The picture will be taken.

Playing Back Still Pictures p.26



The aperture value will be saved when the camera is turned off.



- The four-way controller (▲▼) becomes the manual focus button and cannot be used to change the aperture value when the focus mode is set to manual. Press the OK button once and then use the four-way controller (▲▼) to change the value to change the aperture value.
- The exposure is not appropriate when the shutter speed is displayed in orange on the LCD monitor.



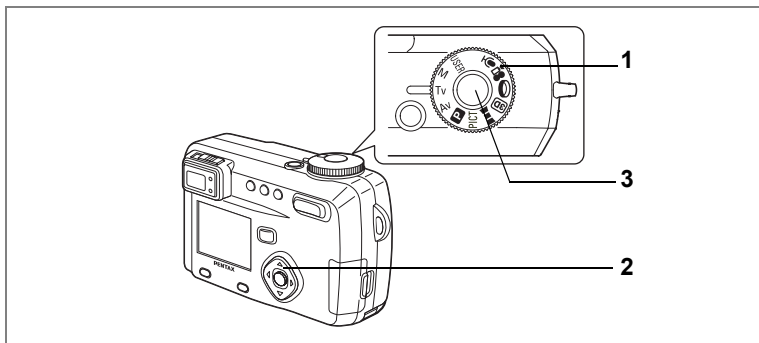

## Setting the Shutter Speed (Shutter-Priority Mode)

In this mode the shutter speed is set manually and the camera automatically sets the aperture value.

- 1 Set the mode dial to Tv.**
- 2 Use the four-way controller (▲▼) to change the shutter speed.**

- ▲ Increases the shutter speed.
- ▼ Reduces the shutter speed.



Shutter speed

- 3 Press the shutter release button.**

The picture will be taken.

Playing Back Still Pictures p.26



The set shutter speed will be saved when the camera is turned off.



- The four-way controller (▲▼) becomes the manual focus button and cannot be used to change the shutter speed when the focus mode is set to manual. Press the OK button once and then use the four-way controller (▲▼) to change the value to change the shutter speed.
- The exposure is not appropriate when the aperture value is displayed in orange on the LCD monitor.

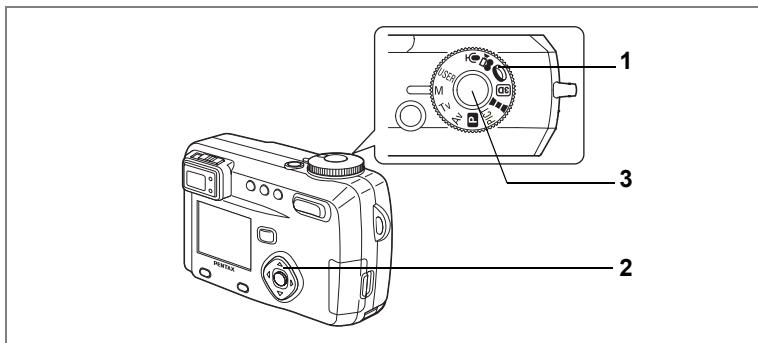

## Setting the Exposure Manually (Manual Exposure Mode)

You can set the shutter speed and aperture value manually.

- 1 Set the mode dial to M.**
- 2 Use the four-way controller to change the shutter speed and aperture value.**

- ◀ Increases the shutter speed.
- ▶ Reduces the shutter speed.
- ▲ Makes the aperture larger.  
(Reduces the aperture value.)
- ▼ Makes the aperture smaller.  
(Increases the aperture value.)

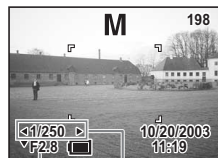

Aperture      Shutter speed

If the combination of shutter speed and aperture value do not give an appropriate exposure, a warning will be displayed.

(Lit)	If the deviation from the appropriate exposure is between $-0.3$ EV and $-2.0$ EV,  will light, and if between $+0.3$ EV and $+2.0$ EV  will light, and the value will be displayed.
(Blinking)	If the picture is underexposed at a setting lower than $-2.0$ EV,  blinks, and if overexposed at a setting higher than $+2.0$ EV,  blinks.
(Lit)	Metering is not possible.

### 3 Press the shutter release button.

The picture will be taken at the set shutter speed and aperture value.

Playing Back Still Pictures  p.26



The shutter speed and aperture value will be saved when the camera is turned off.



- EV compensation is not available in this mode.
- The four-way controller (▲▼) becomes the manual focus button and cannot be used to change the aperture value when the focus mode is set to manual. Press the OK button once and then use the four-way controller (▲▼) to change the value to change the aperture value.
- The [Auto flash] and [Auto flash + Red-eye Reduction] flash modes cannot be selected.

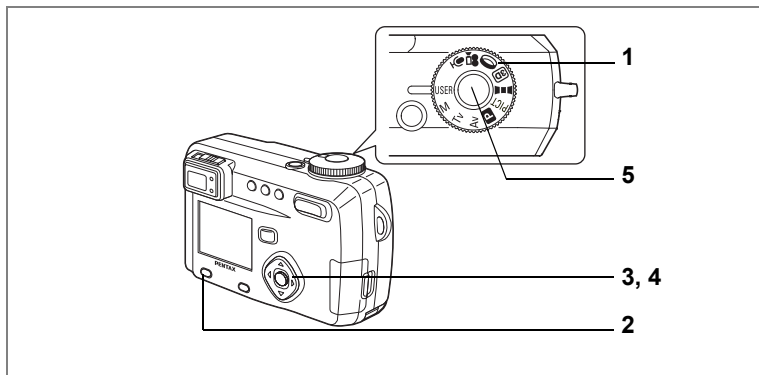

## Using Preset Function Settings (User Mode)

Register Capture mode or functions that you use frequently and then align the mode dial to **USER** to quickly take pictures using your preferred settings.

### Registering a function

- 1** Set the mode dial to **USER**.
- 2** Set the [**Rec. Mode**] items to your preferred settings.
- 3** Press the four-way controller (**▲▼**) to select [**USER**].
- 4** Press the four-way controller (**◀▶**) to select a Capture mode to be saved.

The set functions and Capture mode are registered in [User Mode]. See the table on the next page for the functions that can be set in the User mode.

- 5** Press the shutter release button.

## Registering Functions in User Mode

By setting the mode dial to USER and setting the shooting functions, the functions and Capture mode are registered in User mode.

### ● Functions that can be set in User mode

Function	Default Setting	Ref.
Recorded Pixels	2592 × 1944	p.43
Quality Level	★★	p.44
White Balance	AWB	p.45
Focusing Area	Wide	p.47
AE Metering		p.48
Sensitivity	Auto	p.49
Flash Exp. Comp.	0.0	p.52
Auto Bracket*	–	p.84
Digital Zoom	On	p.75

Function	Default Setting	Ref.
Instant Review*	2 sec	p.50
Interval Shoot*	–	p.80
Fast Fwd Movie	Off	p.80
3D Mode*	Parallel	p.64
Memory	–	p.87
Sharpness	Normal	p.50
Saturation	Normal	p.51
Contrast	Normal	p.51
USER	<b>P</b>	–



- For the USER mode, you can choose from the following six modes: program, manual exposure, aperture priority, shutter priority, picture or digital filter mode.
- Settings made for functions marked with an asterisk (\*) are reflected in other modes as well as User mode.

### 1 Set the mode dial to USER.

### 2 Press the shutter release button.

The picture will be taken.



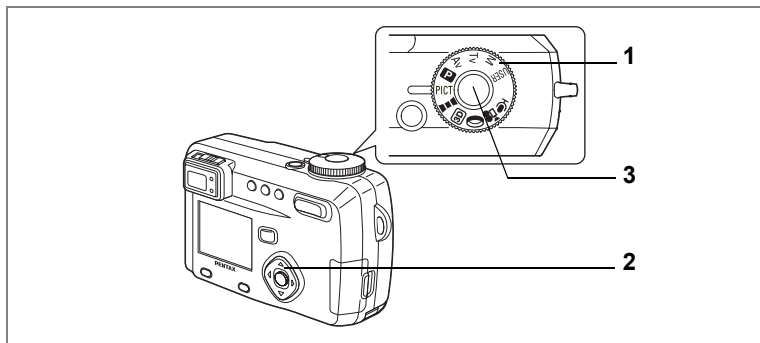

## Selecting the Picture Mode According to the Shooting Scene (Picture mode)

You can select the Picture mode according to the shooting scene.

### ● Picture mode

There are nine available modes in Picture mode.

	Landscape	Enables to take landscape photos with bright colors.
	Night-Scene Mode	Enables you to take dark scenes such as night views.
	Flower	Enables to take flower photos bright in color.
	Portrait	Enables to take portraits with spatial effect, by emphasizing the person.
	Surf & Snow	Enables to take clear photos at dazzling places like beaches and snow covered mountains.
	Autumn Colors	Enables you to take colorful photos of trees in autumn.
	Sunset	Enables to reproduce beautiful colors for sunrise and sunset photos.
	Fireworks	Enables you to take bright photos of fireworks.
	Text	Enables you to take clear photos of text.

- 1 Set the Mode dial to PICT.**
- 2 Use the four-way controller (▲▼) to select the required mode.**
- 3 Press the shutter release button.**

The picture will be taken.

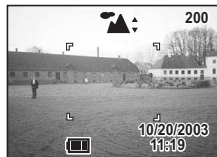



- The picture mode will be saved when the camera is turned off.
- The flash is disabled in Fireworks mode and the focus is fixed at infinity.



- The four-way controller (▲▼) becomes the manual focus button and cannot be used to change the picture mode when the focus mode is set to manual. Press the OK button once and then use the four-way controller (▲▼) to change the picture mode to change the picture mode.
- To avoid camera movement in Night-scene, Sunset and Fireworks mode. You are recommended to fix the camera on a tripod.

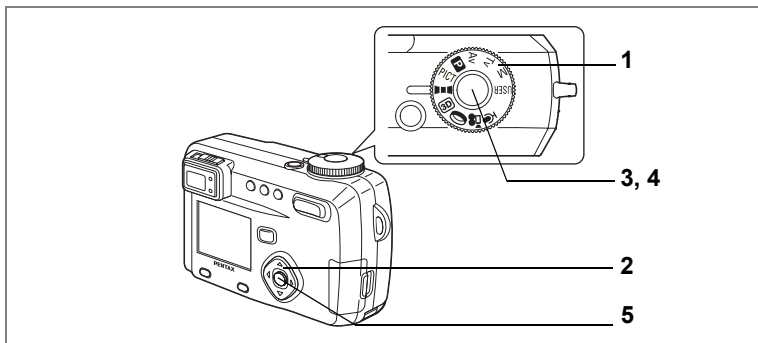

## Taking Panorama Pictures (Panorama Assist Mode)

Using the provided software (ACDSee™), join several pictures on your PC and easily create panoramic photos. Join photos that have been taken so the edges of the images overlap in Panorama Assist Mode to create a single panoramic photo.

- 1 Set the mode dial to .**
- 2 Use the four-way controller to choose the direction in which the images will be joined.**

- ◀ Joins the images at the left.
- ▶ Joins the images at the right.
- ▲ Joins the images at the top.
- ▼ Joins the images at the bottom.

The example shows the images when ▶ is selected.

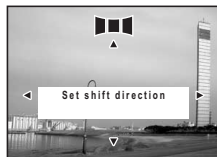

- 3 Take the first picture.**

Press the shutter release button to take the first image. The right edge of the image is displayed in transparent form on the left of the LCD monitor.





#### 4 Move the camera to the right and take the second picture.

Position the camera so that the actual image display overlaps the transparent display on the left edge, and then release the shutter. Repeat the above procedure to take the third and subsequent pictures.



#### 5 Press the OK button.

The screen returns to Step 1.



To cancel Panorama assist mode, change to another mode.



- The camera cannot join the images. Use the panorama software (ACDSee™) provided with the camera.
- See p.32 in the separate booklet (PC connection manual) for instructions on how to create panoramic photos.
- Continuous shooting, Multiple Exposure mode and interval shooting are not possible in Panorama assist mode.
- A computer running Windows is necessary for joining images. (The ACD photostitcher software provided with the camera is not supported by Macintosh.)

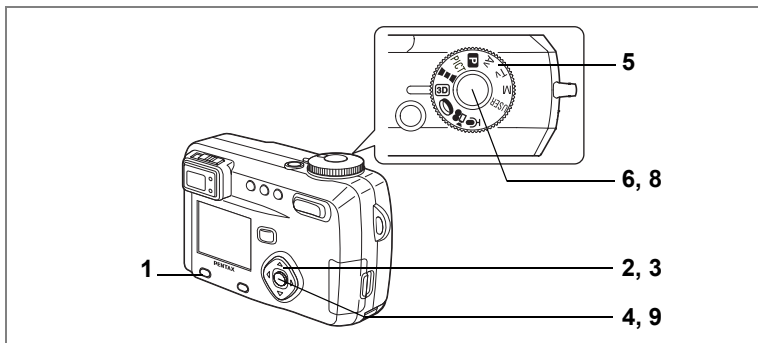

## Taking Stereo Pictures (3D Image Mode)

You can take 3D pictures using the LCD monitor and view them by the parallel method or cross method (p.66). If you print out the 3D pictures taken by parallel method and look at them through the 3D image viewer provided, the image will appear in three dimensions.

Print 3D pictures taken using the parallel method and view them using the provided 3D image viewer. Images will appear three-dimensional.

### Select the 3D mode

The default setting is [Parallel]. If you do not need to switch to [Cross], go to Step 5.

#### 1 Press the Menu / Fn button.

The [Rec. Mode] menu will be displayed.

#### 2 Press the four-way controller (▲▼) to select [3D Mode].

#### 3 Use the four-way controller (◀▶) to select [Cross].

To view the picture with the 3D image viewer, select [Parallel].

You can also view it without the image viewer.

#### 4 Press the OK button.

The 3D image mode screen appears again.

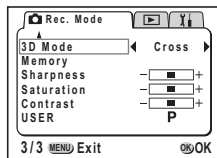

## Taking pictures

### 5 Set the Mode dial to 3D.

The screen for taking the first picture appears in the middle of the LCD monitor.

### 6 Take the first picture.

Hold the camera so that the subject is in the middle of the screen, and press the shutter release button.

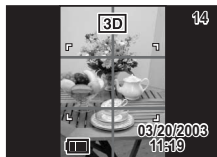

The picture is displayed in the left half screen of the LCD monitor. The right half screen is for taking the second picture.

### 7 Move the camera to right without changing your stance.

### 8 Take the second picture.

Make sure that the subject is in the middle of the right half of the screen and press the shutter release button.

When you have taken the second picture, the screen returns to Step 6.

### 9 Press the Playback button.

The LCD monitor displays both the left and right images.

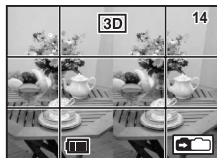

- Press the Menu / Fn button or change the 3D image mode to another Capture mode to cancel the 3D image mode.
- A clear three-dimensional effect will not be achieved if the two images are taken in widely different positions (heights) or are not straight. When taking a person, you are recommended to ask your model to stay as still as possible and to take the second picture as quickly as you can. It is easier to take the pictures if you use a tripod or appropriate base.
- As a guide, the camera should be moved about 1/40 of the distance between the camera and the subject. For example, if the subject is 3m away, the distance the camera should be moved will be  $3\text{m} \div 40 = 7.5\text{cm}$ .  
However, as the way people see three-dimensional images differs from person to person, there is no need to be too concerned. Refer to the table below for a simple guide to how far to move the camera.

Distance to subject	0.1 m	0.3 m	0.5 m	1 m	3 m	5 m
Camera movement	0.5 cm	1 cm	1.5 cm	2.5 cm	7.5 cm	13 cm

**● Viewing 3D pictures by the parallel method and cross method**

As our eyes are positioned about 6 – 7 cm apart, there is a very slight deviation between what we see with our right eye and what we see with our left eye. The difference is processed by our brain to produce a three-dimensional image. This principle is applied to taking and viewing 3D pictures.

3D pictures can be viewed by the parallel method where the left and right lines of vision are virtually parallel, as when looking at a distant scene, or the cross method where the left and right lines of vision are crossed, as when you cross your eyes. A certain amount of practice may be necessary to view 3D pictures without using the viewer.

**● How to Assemble the 3D Image Viewer**

Assemble the 3D image viewer supplied with the camera as shown below.

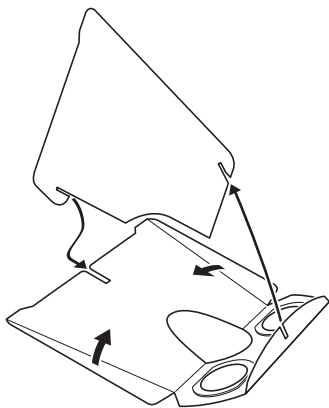

### ● How to view 3D pictures using the 3D image viewer

Print out the pictures so that they are about 11cm or 12cm wide and place the divider of the 3D image viewer in the middle of the two.

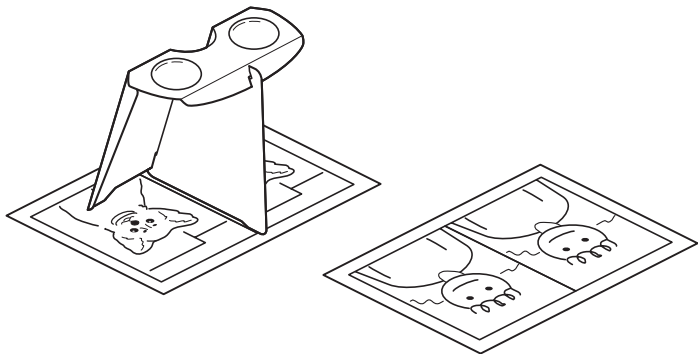

As the distance between the left and right eyes differs from person to person, some people may have difficulty obtaining a three-dimensional effect even when looking at prints that are the same size. It may be especially difficult if the pictures are very large or very small. Try different sizes until the right effect is achieved.



- Never look at the sun through the 3D image viewer.
- Do not leave the 3D image viewer where it is exposed to direct sunlight as this may lead to fire.

● Example of a 3D picture



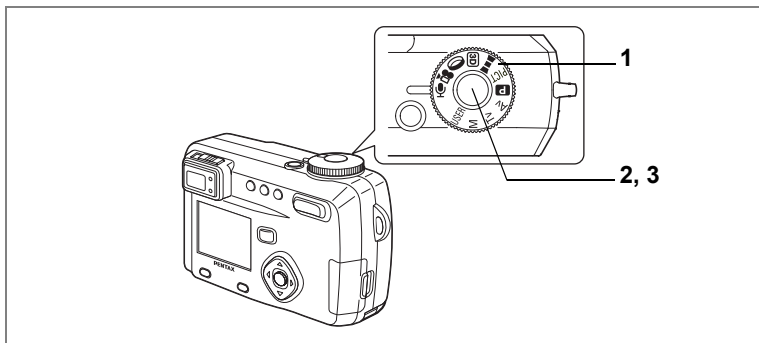

## Recording Sound (Voice Recording Mode)

You can record sound. The recordable time is displayed on the LCD monitor according to how much space is available on the SD Memory Card / MultiMediaCard.

### 1 Set the mode dial to .

The recordable time is displayed on the LCD monitor.

1 Remaining time 2 Recording time



### 2 Press the shutter release button.

Recording starts. The self-timer lamp and flash status lamp blink during recording.

### 3 Press the shutter release button.

Recording stops. The remaining recordable time is displayed.

Playing back sound  p.92



Sound is saved in WAVE monaural files.

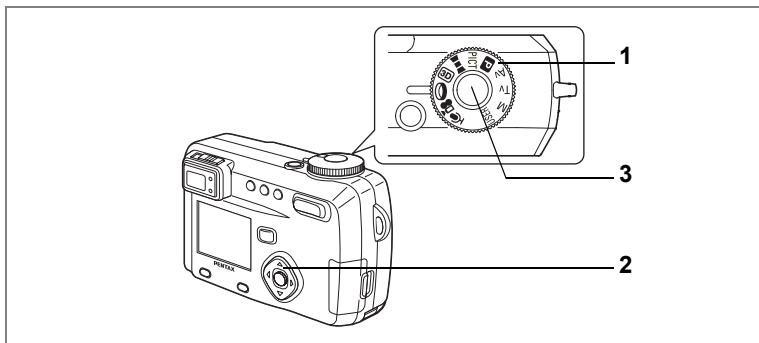

## Taking Pictures with Digital Filters (Digital Filter Mode)

You can take pictures using digital filters. The filters consist of color filters such as red, blue and green, a soft filter that produces a fuzzy effect.



### ● Color filters

Eight colors, black-and-white, sepia, red, pink, violet, blue, green and yellow, are provided for the color filters. When you select a color filter in the Digital Filter mode, the display on the LCD monitor is filtered with the selected color, and the pictures are taken in that color.

### ● Soft Filter

Pictures taken with the soft filter have a fuzzy effect.







- 1 Set the Mode dial to .**
- 2 Use the four-way controller ( ) to select a digital filter to use.**
- 3 Press the shutter release button.**

The picture will be taken.



Playing back still pictures  p.26



The four-way controller ( ) becomes the manual focus button and cannot be used to change the filter when the focus mode is set to manual. Press the OK button once and then use the four-way controller ( ) to change the filter to change the filter.

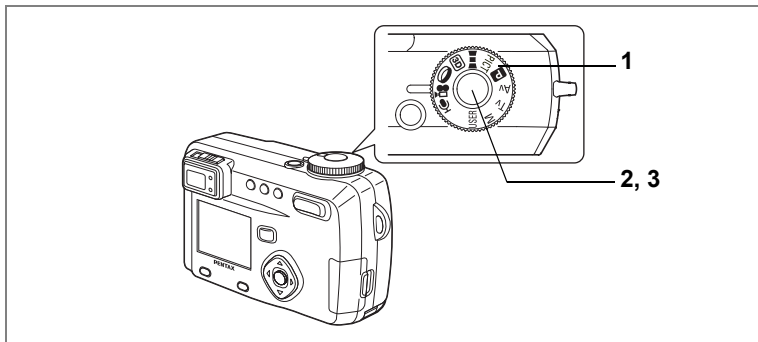

## Taking Movie Pictures (Movie Picture Mode)

This mode enables you to take moving images. The amount of images you can capture is displayed on the top right of the screen. Sound can be recorded at the same time.

### 1 Set the mode dial to .

The following information will be displayed on the LCD monitor.

- 1 Flash OFF
- 2 Movie Picture mode icon
- 3 Remaining shooting time

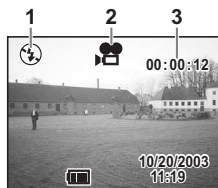

### 2 Press the shutter release button.

Shooting will start.

You can change the size of the image using the Zoom button.

▲ : makes the image bigger.

◆◆ : makes the image smaller.

### 3 Press the shutter release button.

Shooting will end.

The remaining shooting time will be displayed.

## Keeping the shutter release button pressed

Pictures will be taken for as long as you keep the button pressed when you keep the shutter release button pressed for more than one second. Shooting stops when you take a finger off from the shutter release button.

Playing Back Movie Pictures  p.91



- The flash will not discharge in Movie Picture mode.
- Continuous shooting, interval shooting and multiple exposure shooting are not possible in Movie Picture mode.
- The LCD monitor cannot be turned off in Movie Picture mode.
- Focusing Area mode is not available in Movie Picture mode.
- The digital zoom can be operated in Movie Picture mode.
- The focus is fixed and focus mode cannot be selected in the movie picture mode.

You can use the zoom to take pictures in tele or wide mode.

## 1 Press the Zoom button in Capture mode.

- ⬇ (Tele): makes the subject bigger
- ⬆⬆⬆ (Wide): makes the subject smaller

When the digital zoom function is disabled, you can take pictures at up to 5× magnification using the optical zoom.

When the digital zoom is enabled, you can further enlarge the subject to a maximum magnification equivalent to 20×.

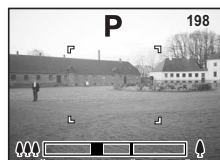

Zoom bar Digital zoom range

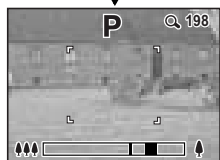

Digital Zoom

Saving the Zoom Position  p.87

## Enabling the Digital Zoom Function

### 1 Press the Menu/Fn button in Capture mode.

The [Rec.Mode] menu will be displayed.

### 2 Press the four-way controller (▼) to select [Digital Zoom].

### 3 Use the four-way controller (▶) to select [On].

### 4 Press the OK button.

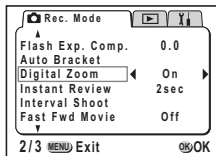

The camera is ready to take a picture.

Saving the Digital Zoom Function Setting p.87



- When you turn the LCD monitor off, the digital zoom is disabled when the digital zoom function is set to On.
- The image will be blurred when shooting an image using the digital zoom function.
- The camera movement may occur due to high magnification. Use the tripod to prevent it when using the digital zoom function.
- The digital zoom is enabled when taking a movie picture.

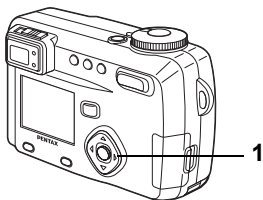

USER Tv Av P PICT

## EV Compensation

4

Taking Pictures

You can take pictures that are intentionally over-exposed or under-exposed.

### 1 Press the four-way controller (◀▶) in Capture mode.

Four-way controller (◀)  
decreases the EV compensation to a  
negative (-) level

Four-way controller (▶)  
increases the EV compensation to a  
positive (+) level

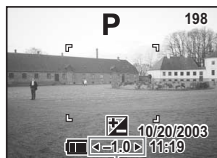

EV compensation level

The set level is displayed on the LCD monitor.

Saving the EV Compensation p.87



- If you press ◀ or ▶ one time, or set to ± 0, the set level displayed on the LCD monitor will go off after two seconds.
- The exposure compensation cannot be set in the Fireworks picture mode.

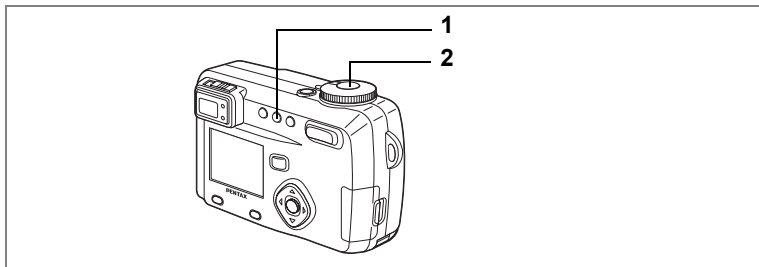

USER M Tv Av P PICT

## Using the Self-timer

The picture will be taken 10 seconds after the shutter release button is pressed.

- 1 Press the button in Capture mode to display on the LCD monitor.**
- 2 Press the shutter release button.**

The self-timer is engaged and the self-timer lamp lights. The picture is taken approximately three seconds after the self-timer lamp starts to blink.

Playing Back Images and Sound p.89



- The second count will be displayed when you turn the LCD monitor on.
- Press the shutter release button halfway while the second count is displayed to cancel the self-timer.

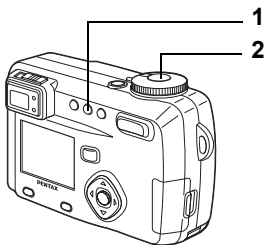

USER M Tv Av P PICT [ ] 3D [ ] [ ]

## Using the Remote Control Unit (optional)

4

You can take pictures using the remote control F (optional).

### 1 Press the button in Capture mode to display on the LCD monitor.

The self-timer lamp will blink and the camera is ready to take pictures.

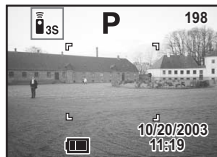

### 2 Press the shutter release button on the remote control unit.

The self-timer lamp will blink rapidly and the picture will be taken after approximately three seconds.



Playing Back Images and Sound  p.89



- The buttons on the camera can be used in the same way.
- Please ensure that the remote control unit is no more than 5 meters away from the front of the camera.
- The distance at which the remote control unit operates may be reduced when taking pictures against the light.
- Press the  button in step 1 to display  on the LCD monitor to take a picture immediately after pressing the shutter release button on the remote control unit.

### ● Life of the Battery for the Remote Control Unit

A signal can be sent from the remote control unit to the camera approximately 30,000 times. If the battery needs changing, contact your nearest Pentax customer service center. (A charge is made for replacing the battery.)



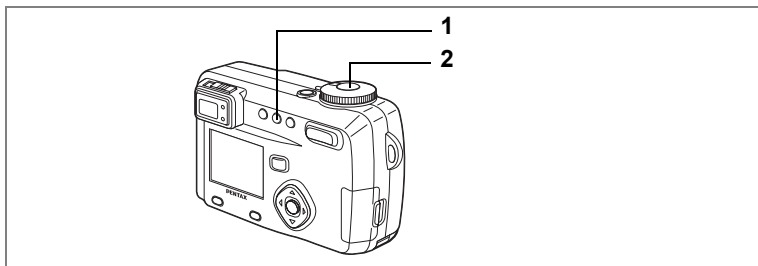

USER M Tv Av P PICT [Battery] [3D] [Flash] [Image]

## Continuous Shooting

Pictures are taken continuously while the shutter release button is pressed.

- 1 Press the  button in Capture mode to display  on the LCD monitor.**

The mode will change to Continuous Shooting mode.

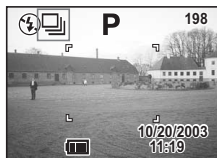

- 2 Press the shutter release button.**

Pictures will be taken continuously while the shutter release button is pressed. Shooting stops when you take a finger off from the shutter release button.

Playing Back Still Pictures  p.26



The interval will vary according to the [Recorded Pixels] and [Quality Level] setting.



- The flash will not discharge in Continuous Shooting mode.
- Continuous shooting is not available for Movie Picture, Panorama assist mode and 3D Image modes.

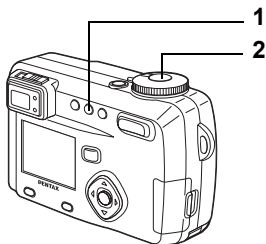

USER M Tv Av P PICT

## Taking Pictures at Fixed Intervals (Interval Shooting)

4

In this mode still pictures are taken automatically at a fixed interval.

**1** Press the button in Capture mode to display on the LCD monitor.

**2** Press the shutter release button.

Interval shooting will start with the following settings.

- Interval 0min 10sec
- Number of shot 02
- Start time 0hr 0min

The camera turns off automatically when shooting is finished.



- Interval shooting can be set at intervals of 10 seconds to 4 minutes in units of 1 second, and intervals of 4 minutes to 99 minutes in units of 1 minute. Intervals of less than 10 seconds cannot be set.
- The number of pictures can be set in the range of 2 to 99 pictures.
- The start time can be set between 0 min. and 23 hr. 59 min. in units of 1 minute.
- If the start time is set to 0 min., the first picture will be taken as soon as the shutter release button is pressed.
- The remaining number of pictures and interval time will be displayed on the LCD monitor when you press the power switch on during standby. If you press the Menu / Fn button, the message "Stop interval shooting?" will be displayed. To cancel interval shooting, press the OK button.
- Interval shooting stops and the camera turns off automatically when the SD Memory Card / MultiMediaCard runs out of memory space.



Interval shooting is not possible in mode.

## Setting the interval, number of shot, and start time

### 1 Press the Menu / Fn button in Capture mode.

The [Rec.Mode] menu will be displayed.

### 2 Press the four-way controller (▼) to select [Interval Shoot].

### 3 Press the four-way controller (▶).

The Interval Shooting menu will be displayed and [Interval] will be framed.

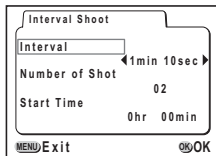

### 4 Set the interval time.

#### 1. Press the four-way controller (▶).

▲▼ will be displayed above and below the minutes.

#### 2. Use the four-way controller (▲▼) to change the minutes, then press (▶).

▲▼ will be displayed above and below the seconds.

#### 3. Use the four-way controller (▲▼) to change the seconds, then press (▶).

#### 4. Press the four-way controller (▼).

The frame will move to [Number of shoot].

### 5 Use the four-way controller (◀▶) to select the number of pictures, then press (▼).

The frame will move to [Start Time].

### 6 Set the time to start shooting.

#### 1. Press the four-way controller (▶).

▲▼ will be displayed above and below the hours.

#### 2. Use the four-way controller (▲▼) to change the hours, then press ▶.

▲▼ will be displayed above and below the minutes.

#### 3. Use the four-way controller (▲▼) to change the minutes, then press (▶).

### 7 Press the OK button twice.

Playing Back Still Pictures p.26

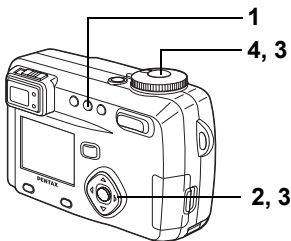

USER M Tv Av **P** PICT 3D

## Superimposing One Picture on Top of Another (Multiple Exposure Mode)

You can superimpose a new image on top of an image already recorded.

### When images have been recorded

- 1 Press in Capture mode to switch to Multiple Exposure mode.

The screen for selecting the base image will be displayed.



- 2 Use the four-way controller (◀▶) to choose the base image and press the OK button.

The selected image will appear in transparent form on the LCD monitor.

- 3 Aim the camera at your subject and choose the exposure method with the four-way controller (▲▼).

- Priority is given to the brighter image.
- Priority is given to the darker image.
- The average exposure is obtained.



Exposure method

- 4 Press the shutter release button.

The Instant Review screen will be displayed and you will be asked whether you want to continue shooting.

If you select [Continue] and press the OK button, the picture you have just created will be played back enabling you to add another image.

The combined picture will be saved as a new file.

## When there are no recorded images



### 1 Press in Capture mode to switch to Multiple Exposure mode.

A message will appear on the LCD monitor informing you that the camera is ready to take the base image.

Take the base image. When you have taken the base image, it will appear in transparent form on the LCD monitor.



### 2 Aim the camera at your subject and choose the exposure method with the four-way controller ( ).

-  Priority is given to the brighter image.
-  Priority is given to the darker image.
-  The average exposure is obtained.



Exposure method

### 3 Press the shutter release button.





The Instant Review screen will be displayed and you will be asked whether you want to continue shooting.

If you select [Continue] and press the OK button, the picture you have just created will be played back enabling you to add another image.

The combined picture will be saved as a new file.

Playing Back Still Pictures  p.26

#### Caution

- Multiple exposure is not possible in     mode.
- Continuous shooting is not possible in Multiple Exposure mode.
- The LCD monitor cannot be turned off in Multiple Exposure mode.

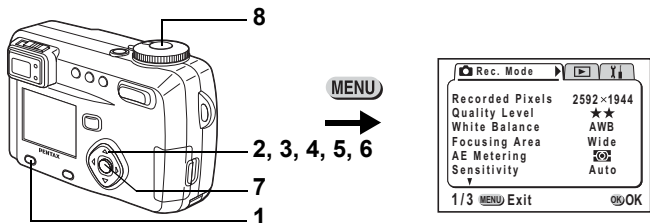

M Tv Av P PICT 3D USER

## Automatically Changing the Shooting Conditions (Auto bracket)

4

You can take pictures automatically with three different exposure, white balance, sharpness, saturation and contrast settings.

### 1 Press the Menu / Fn button in Capture mode.

The [Rec. Mode] menu will be displayed.

### 2 Press the four-way controller (▼) to select [Auto Bracket].

### 3 Press the four-way controller (▶).

[Applied Photo] screen to select the bracket setting will be displayed.

### 4 Use the four-way controller (◀▶) to select the conditions for bracket shooting.

If you selected [Sharpness], [Saturation] or [Contrast], skip to step 7.

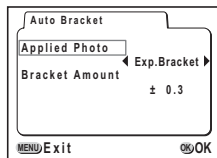

### 5 Press the four-way controller (▼) to select [Exp. Bracket] or [White Balance].

Go to [Bracket Amount].

### 6 Use the four-way controller (◀▶) to set the bracketing steps.

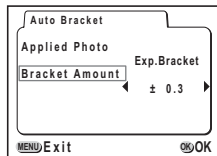

## 7 Press the OK button.

The Bracket mode is set.

## 8 Press and hold down the shutter release button.

Auto bracket shooting starts.

When shooting is finished, a message will be displayed asking whether you want to continue shooting or not. To continue shooting in auto bracket mode, select [Continue] and press the OK button.

Playing Back Still Pictures  p.26



- Check the pictures you have taken using the Playback mode.
- If you set auto bracket when you set the Continuous shooting mode, continuous shooting will be cancelled.
- The auto bracket setting will be cancelled by pressing the Menu / Fn button or OK button.

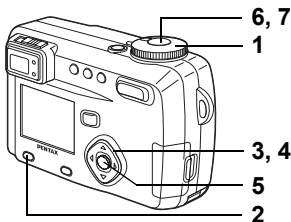

## Taking Fast Forward Movie Pictures (Fast Fwd Movie)

This mode lets you take movie pictures at a delayed frame rate so that when you play the movie back, the action appears speeded up.

- 1 Set the mode dial to .**
- 2 Press the Menu / Fn button in Capture mode.**  
The [Rec.Mode] menu will be displayed.
- 3 Press the four-way controller (▼) to select [Fast Fwd Movie].**
- 4 Use the four-way controller (◀▶) to choose [Off (×1)], [×2], [×5], [×10], [×50] or [×100].**
- 5 Press the OK button.**
- 6 Press the shutter release button.**  
Shooting in Fast Forward Movie mode starts.
- 7 Press the shutter release button.**  
Shooting in Fast Fwd Movie mode ends.

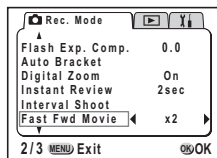

Playing Back Movie Pictures  p.91







- Off (×1) is the normal setting for movie pictures (15 frames per second). Each time ×2 or ×5 is selected, the number of frames taken per second is reduced to 1/2 or 1/5.
- As movie pictures are normally played back at the rate of 15 frames per second, movies taken at ×2 are played back twice as fast and movies taken at ×5 are played back five times as fast.
- Sound cannot be recorded.



# Saving the Settings (Memory)

## Saving the Menu Items (Memory)

You can choose whether you want the set values to be saved when the camera is turned off. If you select [On], the settings will be saved in the status they were in immediately before the camera was turned off. If you select [Off], the settings will be reset to the defaults when the camera is turned off.

Item	Description	Default Setting
Flash	The flash mode setting on the  button is saved.	Off
Flash Exp. Comp.	Saves the Flash Compensation setting.	0.0
White Balance	The [White Balance] setting on the [  Rec.Mode] menu is saved.	Off
EV Compensation	The set EV compensation value is saved.	Off
Digital Zoom	The [Digital Zoom] setting on the [  Rec.Mode] menu is saved.	On
AE Metering	The [AE Metering] setting on the [  Rec.Mode] menu is saved.	Off
Sensitivity	The [Sensitivity] setting on the [  Rec.Mode] menu is saved.	Off
Focus Mode	The focus mode setting is saved.	Off
Zoom Position	The zoom position setting is saved.	Off
MF Position	The focus position set by Manual Focus is saved.	Off
DISPLAY	The LCD monitor display mode is saved.	Off
File No.	The file number is saved. If a new SD Memory Card / MultiMediaCard is inserted, the sequential file number is assigned.	On



- Menu items not included in [Memory] will also be saved in the settings selected on the menus for each function when the camera is turned off.
- The zoom position setting in the digital zoom range will not be saved when [Zoom Position] is set to On in [Memory].
- The Auto Bracket setting is not saved.
- [Memory] can be set separately in User mode and other Capture modes.
- [Zoom Position] will be set to On automatically when [MF Position] is set to On.

- 1 Press the Menu / Fn button in Capture mode.
- 2 Press the four-way controller (▲▼) to select [Memory].
- 3 Press the four-way controller (▶).  
[Memory] menu will be displayed.
- 4 Use the four-way controller (▲▼) to select the item.
- 5 Use the four-way controller (◀▶) to switch  [On] and  [Off].
- 6 Press the OK button twice.

The camera is ready to take the picture.

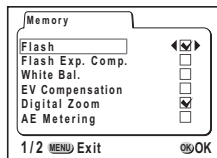
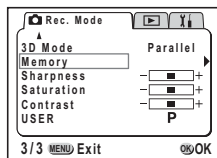

# Playing Back Images and Sound

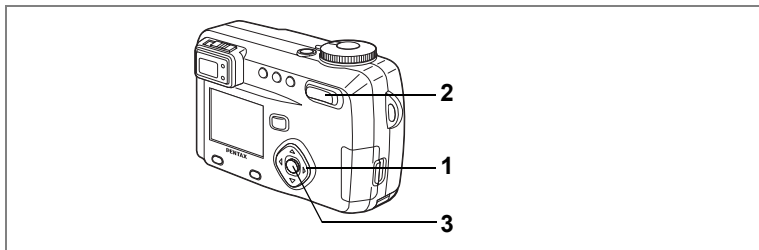

## Playing Back Still Pictures

See “Playing Back Still Pictures” (p.26).

## Zoom Display

You can display images magnified up to 8 times. A guide to operation is displayed on the LCD monitor during magnification.

**1 Enter the Playback mode and choose the image you want to magnify with the four-way controller (◀▶).**

**2 Press ▲/Q on the Zoom / [ ]/Q button.**

The image will be magnified (1× to 8×).

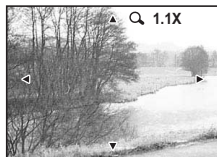

• **The following operations can be performed while the magnified image is displayed.**

Four-way controller (▲▼◀▶) : Moves the position to be magnified

Zoom / [ ]/Q button (▲) : Makes the image larger

Zoom / [ ]/Q button (▼) : Makes the image smaller

Display button : Turns the guide marks on / off

**3 Press the OK button.**

Zoom playback will end.



If you set the magnification for [Quick Zoom] in the [X] Setup menu in advance, the image will be displayed in the set magnification when the ▲/Q button of the Zoom / [ ]/Q button is pressed once.



Movie pictures cannot be magnified.

## Adding a Voice Memo

You can add a voice memo to a recorded image.

- 1 Enter the playback mode and choose the image to which you want to add a voice memo with the four-way controller (◀▶).**

If the image has no voice memo, the screen for recording a voice memo is displayed on the LCD monitor.



- 2 Press the OK button.**

Recording starts. You can record for up to 30 seconds.

- 3 Press the OK button.**

Recording stops.

- 4 Press the four-way controller (▲).**

Play back the recorded voice memo.

- 5 Press the four-way controller (▲).**

Playback stops.



- A voice memo cannot be added to protected (🔒) images.
- 🔒 is displayed on the LCD monitor next to images with a voice memo.

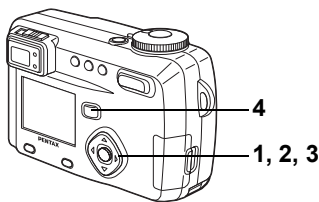

## Playing Back Movie Pictures

You can play back Movie pictures. A guide to operation is displayed on the LCD monitor during playback. The sound is played back at the same time.

**1 Enter the Playback mode and choose the movie picture you want to play back with the four-way controller (◀▶).**

**2 Press the four-way controller (▲).**

Playback will start.

- The following operations can be performed during playback.

Four-way controller (◀) : Reverse playback

Four-way controller (▶) : Forward playback

Four-way controller (▲) : Pause

Zoom / [Z]/[Q] button (▲) : Increases the volume

Zoom / [Z]/[Q] (▼) button : Reduces the volume

Display button : Changes the Display mode

- The following operations can be performed while Pause is engaged.

Four-way controller (◀) : Frame reverse

Four-way controller (▶) : Frame forward

Four-way controller (▲) : Releases the Pause function

Display button : Changes the Display mode

**3 Press the four-way controller (▼).**

Movie playback will end.

**4 Press the Playback button.**

The camera will return to Capture mode.

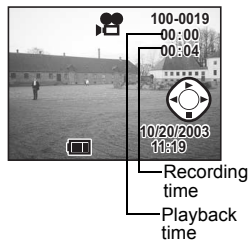

Recording time  
Playback time

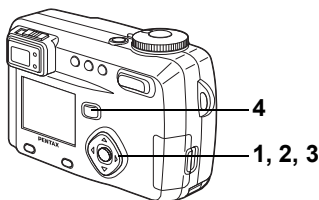

## Playing Back Sound

You can play back the recording you made in Voice Recording mode.

**1 Enter the Playback mode and choose the recording you want to play back with the four-way controller (◀▶).**

**2 Press the four-way controller (▲).**  
Playback will start.

Playback time

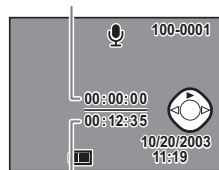

Recording time

• **The following operations can be performed during playback.**

Four-way controller (◀): Rewinds and plays back the recorded sound

Four-way controller (▶): Advances and plays back the recorded sound

Zoom / [M] / [Q] button (▲): Increases the volume

Zoom / [M] / [Q] button (▼): Reduces the volume

**3 Press the four-way controller (▼).**

Sound playback will end.

**4 Press the Playback button.**

The camera will return to the Capture mode.

## Playing back Shooting Information (Playback Mode)

You can display shooting information on the LCD monitor. Use the Display button to change the information displayed.

### Display On

Playback information is displayed.

- 1 Folder No.
- 2 File name
- 3 Protect icon
- 4 Voice memo icon
- 5 Four-way controller operation guide
- 6 Date & time
- 7 Battery indicator

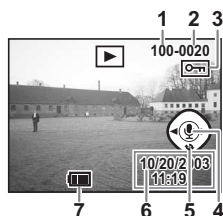

### Histogram Display

The brightness distribution of the image is displayed.

The x-axis shows the brightness (darkest at the left end and brightest at the right end) and the y-axis shows the number of pixels.

- 1 Histogram
- 2 Recorded pixels
- 3 Quality level
- 4 White balance
- 5 AE metering
- 6 Sensitivity
- 7 Aperture value
- 8 Shutter speed

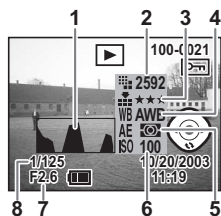

### Display Off

No playback information is displayed.



Display On

5

Playback / Erasing

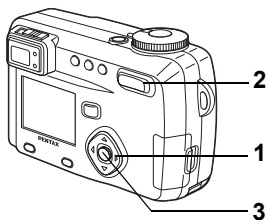

## Nine-image Display

You can display nine images at the same time.

- 1 Enter the Playback mode and choose an image with the four-way controller (◀▶).**
- 2 Press on the Zoom button / .**



Selected image

Nine images will be displayed with the selected image in the center. Choose an image with the four-way controller (▲▼◀▶). When ten or more images have been recorded, if you press the four-way controller (▶) while the bottom right image is selected, the next nine images will be displayed, and if you press the four-way controller (◀) while the top left image is selected, the previous nine images will be displayed. Similarly, if you press the four-way controller (▲) while an image on the top row is selected, the previous nine images will be displayed, and if you press the four-way controller (▼) while an image on the bottom row is selected, the next nine images will be displayed.

- 3 Press the OK button.**

The screen will return to single-image display of the selected image.



Sound files are displayed in .



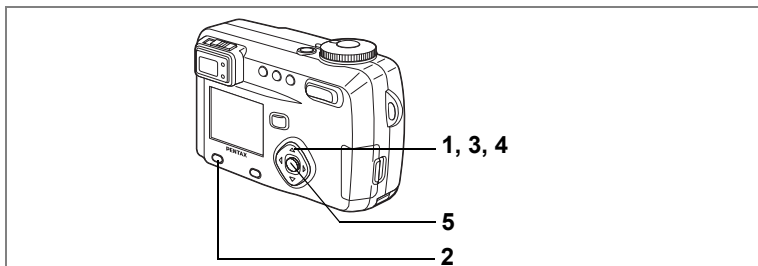

## Slideshow

You can play back all the images on the SD Memory Card / MultiMediaCard continuously.

**1 Enter the Playback mode and choose the image with which to start the slideshow with the four-way controller (◀▶).**

**2 Press the Menu / Fn button.**

The [▶ Playback] menu will be displayed.

**3 Select [Slideshow] with the four-way controller (▼).**

**4 Use the four-way controller (◀▶) to change the playback interval.**



Choose from the following: 3 sec, 5 sec, 10 sec, 20 sec, 30 sec.

**5 Press the OK button.**

Playback will start at the set interval.



- The slideshow will stop when you press the four-way controller, or any buttons such as the Menu / Fn button during continuous playback.
- The slideshow will continue until you press any button.
- Movie pictures and pictures with a voice memo will be played through to the end before the next picture is played back, regardless of the set playback interval.

# Erasing Images

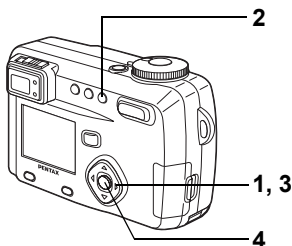

## Erasing a Single Image or Sound

- 1 Enter the Playback mode and choose the image or sound you want to erase with the four-way controller (◀▶).**
- 2 Press the  button.**  
The Delete screen will be displayed.
- 3 Select [Delete] with the four-way controller (▲).**
- 4 Press the OK button.**



- You can also delete images from Instant Review (p.25).
- You cannot erase protected images (with the  symbol).
- When [Quick Delete] is set to On in the [X] Set-up] menu, Step 3 can be omitted.

## Erasing a Voice Memo

If an image has a voice memo (🗣️ is displayed), you can erase the voice memo without erasing the image.

- 1 Enter the Playback mode and choose the image with the voice memo that you want to erase with the four-way controller (◀▶).**
- 2 Press the 🗑️ button.**  
The Sound Delete screen will be displayed.
- 3 Select [Sound Delete] with the four-way controller (▲).**
- 4 Press the OK button.**

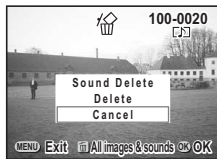

Select [Delete] in step 3 above to erase both the image and the voice memo.

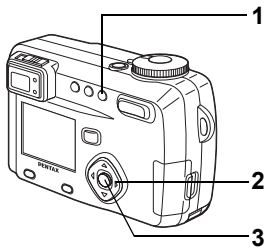

## Erasing All Images

You can erase all the images / sound at once.



- Once erased, images / sound cannot be restored.
- Protected images / sound cannot be erased.

### 5 Playback / Erasing

**1 Enter the Playback mode and press the  button twice.**

The Delete screen will be displayed.

**2 Select [Delete All] with the four-way controller (.**

**3 Press the OK button.**

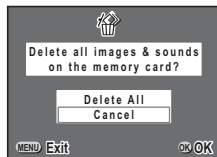

When [Quick Delete] is set to On in the [ Set-up] menu, step 2 can be omitted.

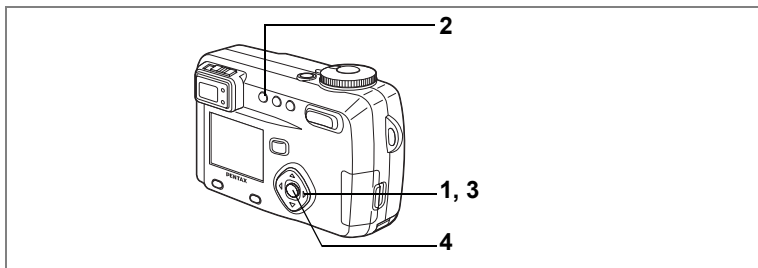

## Protecting Images from Deletion (Protect)

You can protect images / sound from being accidentally erased.

- 1 Enter the Playback mode and choose the image / sound you want to protect with the four-way controller (◀▶).**
- 2 Press the  button.**  
The Protect screen will be displayed.
- 3 Press the four-way controller (▲).**  
The frame will move to [Protect].
- 4 Press the OK button.**

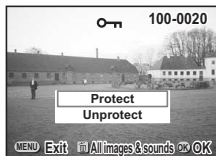

- Select [Unprotect] in step 3 to cancel the Protect setting.
- If the image is protected, the  symbol is displayed when the image / sound is played back.

## Protecting All Images / Sound

You can protect all the images / sound.

- 1 Enter the Playback mode.**
- 2 Press the  button twice.**  
The protect all images & sounds screen will be displayed.
- 3 Press the four-way controller (▲).**  
The frame will move to [Protect].
- 4 Press the OK button.**



Select [Unprotect] in step 3 to cancel the Protect setting on all of the images.



Even protected images / sound will be erased by formatting the SD Memory Card / MultiMediaCard.

# Viewing Images on a TV

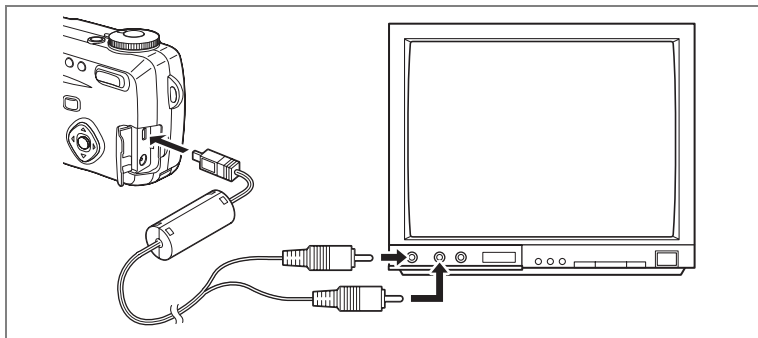

**5** By using the AV cable, you can capture and play back images on a TV or other equipment with a video IN jack. Make sure that both the TV and the camera are turned off before connecting the cable.

- 1** Open the terminal cover and connect the AV cable.
- 2** Connect the sound terminal (white) and image terminal (yellow) of the AV cable to the sound terminal (white) and image input terminal (yellow) of the TV.
- 3** Turn the TV and camera on.

Changing the Video Output Format  p.119



The LCD monitor is always turned off when the camera is connected to a TV. If you intend to use the camera for a long time, use of the AC adapter (optional) is recommended. Refer to the operating manual for the TV or equipment to which the camera is connected.

# Setting the Printing Service (DPOF)

You can print the images on the SD Memory Card / MultiMediaCard using a DPOF (Digital Print Order Format) compatible printer or at a printing service.

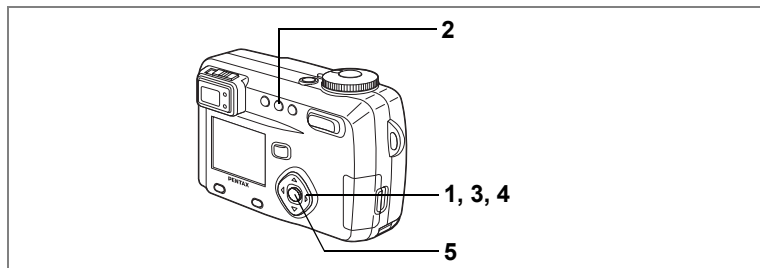

## Printing Single Image

Set the following items for each image.

- **Copies**

Set the number of prints up to a maximum of 10.

- **Date**

Specify whether you want the date imprinted on the print or not.

- 1 Enter the Playback mode and use the four-way controller (◀▶) to choose the image for which you want to make DPOF settings.**
- 2 Press the DPOF button.**

The DPOF screen will be displayed.



### 3 Use the four-way controller (◀▶) to select the number of prints, then press the four-way controller (▼).

The frame will move to [Date].



### 4 Use the four-way controller (◀▶) to select whether to insert the date or not.

- : The date will be imprinted
- : The date will not be imprinted

### 5 Press the OK button.

Prints can be made according to the settings.



- If DPOF settings have already been made for an image, the previously set number of prints and On / Off date setting will be displayed.
- To cancel DPOF settings, set the number of prints to 00 and press the OK button.



- You cannot set the printing service for movie pictures.
- Depending on the printer or printing equipment at the photo processing lab., the date may not be imprinted on the pictures even if the DPOF setting was made.



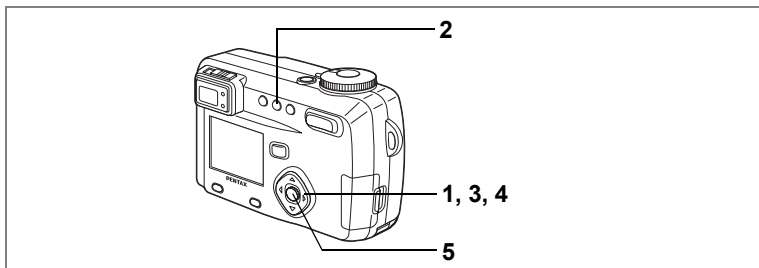

## Printing All Images

- 1 Enter the Playback mode and press the DPOF button twice.**

The [All Images] screen will be displayed.

- 2 Use the four-way controller (◀▶) to select the number of prints.**

You can print up to 10 copies.

- 3 Press the four-way controller (▼).**

The frame will move to [Date].

- 4 Use the four-way controller (◀▶) to select  (On) or  (Off).**

:The date will be printed.

:The date will not be printed.

- 5 Press the OK button.**

Prints can be made according to the settings.

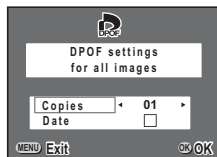

- The setting for a single image will be cancelled.
- The number applies to all the images. Before printing, check that the number is correct when you specify the number of prints in the DPOF setting.
- The setting is not possible for movie pictures.

# Printing Directly from the Camera Connected to a Printer

When you use the USB cable provided with the camera (I-USB7) to connect the camera to a printer that supports PictBridge, you can print images directly from camera without using a PC. The selection of the images to print and the number of prints are set using the controls on the camera after the camera has been connected to the printer. You can use settings for printing services to print one image at a time.



- We recommend that you use the AC adaptor D-AC7 while the camera is connected to a printer. The printer not operate correctly or image data may be damaged when the power for the battery runs low while the camera is connected to the printer.
- Depending on the type of printer, camera settings (such as image quality and DPOF settings) may not be reflected.

5

## Connecting the camera to the printer

- 1 Enter the Playback mode, then press the MENU / Fn button.**

The Playback menu appears.

- 2 Use the four-way controller (▲▼) to select [PictBridge].**

- 3 Press the four-way controller (▶).**

The message "Connect camera & printer" is displayed.

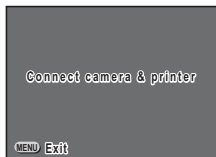

- 4 Connect the camera and printer with supplied USB cable. The image is displayed for printing.**

## Printing one image at a time

The screen for printing images is displayed.

- 1 Use the four-way controller (◀▶) to select the image to print.**
- 2 Use the four-way controller (▲▼) to select the number of prints.**
- 3 Press the OK button.**

You can set up to 10 prints.

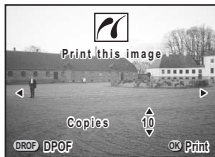

The image is printed using the selected setting.

The message "Continue printing ?" is displayed after the image has been printed. Press the OK button to return to step 1 and continue printing.

## Printing using the printing service settings

The screen for printing images is displayed.

- 1 Press the DPOF button while the screen for selecting an image to print is displayed.**
- 2 Use the four-way controller (◀▶) to select the image to print.**
- 3 Press the OK button.**

The images with a printing service setting are displayed.

To return to the screen for selecting any image, press the DPOF button again.



The selected image is printed using the printing service settings set for the image.

The message "Continue printing ?" is displayed after the image has been printed. Press the OK button to return to step 1 and continue printing.

## Disconnecting the camera from the printer

After you have finished printing images, disconnect the camera from the printer.

- 1 Turn the camera off.**
- 2 Disconnect the USB cable from the camera and the printer.**



If you press the MENU / Fn button while the “Continue printing ?” message is displayed, the message “Safely remove USB cable” is displayed.

When you disconnect the USB cable from the camera, the camera automatically switches to Capture mode.

## Editing Images

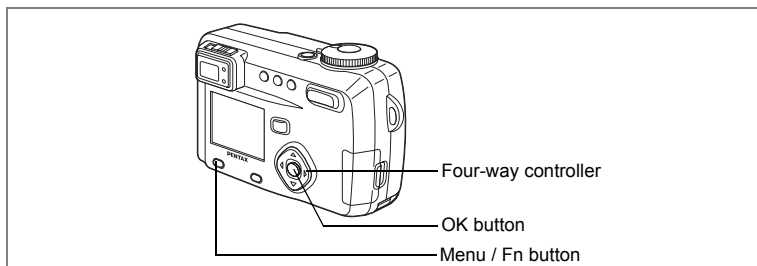

## Changing the Image Size

You can make the file smaller than the original by changing the size and quality of a selected image. After changing the size, the image can be saved as a new image or written over the original image.

- 1 Press the Menu / Fn button.**
- 2 Press the four-way controller (▶).**  
The [▶ Playback] menu will be displayed.
- 3 Use the four-way controller (▲▼) to select [Resize].**
- 4 Press the four-way controller (▶).**  
The Resize screen will be displayed.

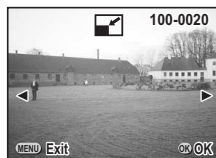

- 5 Use the four-way controller (◀▶) to choose the image you want to resize.**

**6** Press the OK button.



**7** Press the four-way controller (◀▶) to select [Recorded pixels].

**8** Press the four-way controller (▼).

The frame will move to [Quality Level].

**9** Use the four-way controller (◀▶) to select [Quality Level].

**10** Press the OK button.

**11** Use the four-way controller (▲▼) to select [Overwrite] or [Save as].

**12** Press the OK button.

The image will be resized.

6



- Movie pictures cannot be resized.
- You cannot select a larger size than that of the original image.
- You cannot select a higher quality level than that of the original image.

## Trimming Images

You can trim part of a picture and save it as a separate image.

**1 Press the Menu / Fn button.**

**2 Press the four-way controller (▶).**

The [▶ Playback] menu will be displayed.

**3 Press the four-way controller (▲▼) to select [Trimming].**

**4 Press the four-way controller (▶).**

The image that can be trimmed.

**5 Choose the image you want to trim with the four-way controller (◀▶).**

**6 Press the OK button.**

The trimming screen will be displayed.

**7 Trim the image.**

- Operations available on the Trimming screen.

Zoom / [Z]/ [Q] button	: Changes the size of the image
Display button	: Switches between horizontal and vertical
Four-way controller (▲▼◀▶)	: Moves the trimming position up, down, right and left
Menu / Fn button	: Returns to the screen for selecting an image to be trimmed

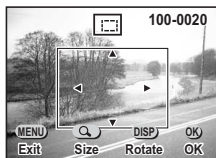

**8 Press the OK button.**

**9 Select the Quality level after trimming with the four-way controller (◀▶).**

**10 Press the OK button.**

The trimmed image will be saved as a separate image.

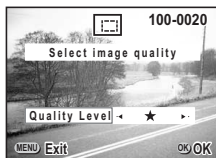

- Movie pictures cannot be trimmed.
- You cannot select a higher quality than that of the original image.

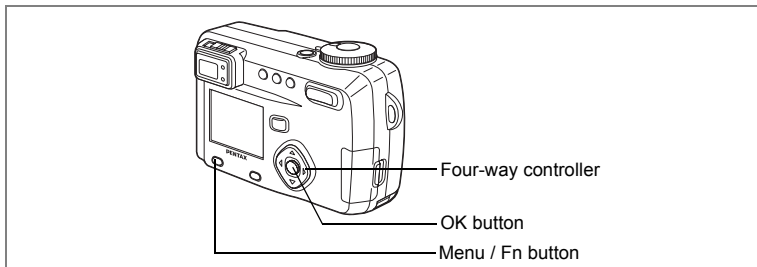

## Using Digital Filters to Edit Images

The digital filters include filters that can apply a red, blue, or green or other color filter to images, a soft filter, and a filter to adjust the brightness of images. In digital filter mode, you can use these filters to modify images.

### ● Color filters

The color filters include a black and white filter, sepia, red, pink, purple, blue, green, and yellow filters. When you select a color filter, the image is displayed on the LCD monitor with the filter effect applied and you can save the modified image.

### ● Soft filter

You can save the image with a soft effect when you apply the soft filter.





### ● Brightness filter

You can save the image as darker or lighter image when you apply the brightness filter.



- 1 Press the MENU button.**
- 2 Press the four-way controller (▶).**  
The Playback menu is displayed.
- 3 Use the four-way controller (▲▼) to select [Digital Filter].**
- 4 Press the four-way controller (▶).**  
The digital filter screen is displayed.
- 5 Use the four-way controller (◀▶) to select the type of filter.**
- 6 Use the four-way controller (▲▼) to select the filter.**



- **If you selected the brightness filter**  
Zoom /  /  button (▲) :brightens the image.  
Zoom /  /  button (▼) :darkens the image.

- 7 Press the Ok button.**
- 8 Use the four-way controller (▲▼) to select [Save as...] or [Save].**
- 9 Press the OK button.**  
The image is saved with the filter affect applied to the image.

# Camera Settings

## How to recall [Yi Set-up] menu

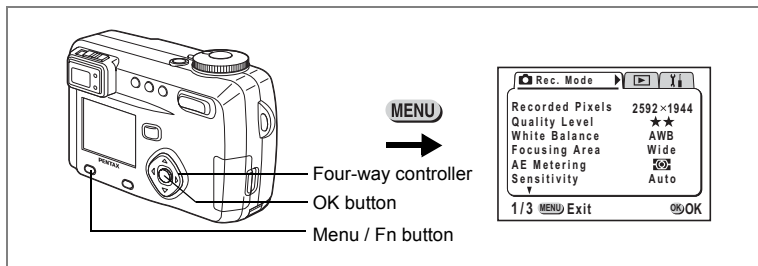

## Formatting a SD Memory Card / MultiMediaCard

Formatting will delete all the data on the SD Memory Card / MultiMediaCard.



- Do not remove the SD Memory Card / MultiMediaCard while the card is being formatted. The card may be damaged and become unusable.
- SD Memory Cards / MultiMedia Cards formatted on a PC or device other than the camera cannot be used.  
Be sure to format the card with the camera.
- Formatting will delete protected data too.

**1** Select [Format] on the [Yi Set-up] menu.

**2** Press the four-way controller (▶).

The Format screen will be displayed.

**3** Select [Format] with the four-way controller (▲).

**4** Press the OK button.

Formatting will start. The camera is ready to capture or play back images when formatting is completed.



## Changing the Sound Settings

You can change the volume of the start-up sound, shutter sound and operation sounds. You can also change the type of each sound.

### Changing the volume

- 1 Select [Sound] on the [Set-up] menu.**
- 2 Press the four-way controller (▶).**

The Sound screen will be displayed.

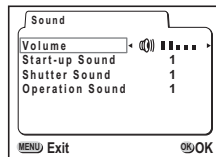

- 3 Use the four-way controller (◀▶) to change the volume.**
- 4 Press the OK button twice.**

The camera is ready to capture or play back images.

## How to recall [Yi Set-up] menu

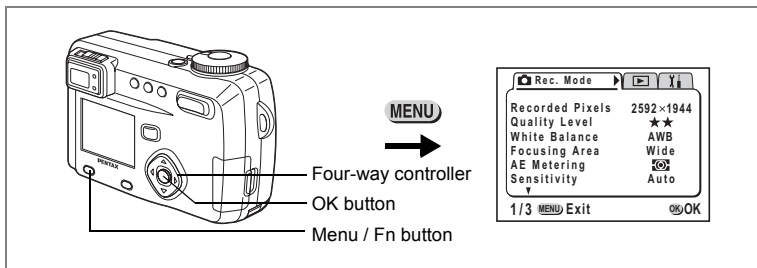

### Changing the type of start-up, shutter or operation sound

- 1 Select [Sound] on the [Yi Set-up] menu.**
- 2 Press the four-way controller (▶).**

The Volume screen will be displayed.
- 3 Press the four-way controller (▲▼) to select [Startup Sound] and choose [1], [2], [3] or [off] with the four-way controller (◀▶).**
- 4 Change the [Shutter Sound] and [Operation Sound] in the same way.**
- 5 Press the OK button twice.**

The camera is ready to capture or play back images.

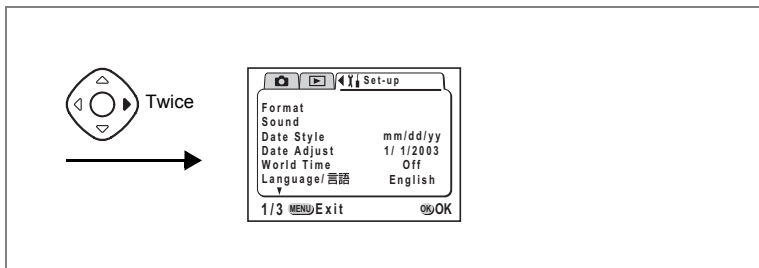

## Setting the Date Style

You can set the style in which the date is displayed on the camera. Choose [mm/dd/yy], [dd/mm/yy] or [yy/mm/dd].

- 1 Select [Date Style] on the [Set-up] menu.**
- 2 Use the four-way controller (◀▶) to change the date style.**
- 3 Press the OK button.**

The camera is ready to capture or play back images with the selected date style.



The style in which the time is displayed is set by [Date Adjust].

## How to recall the [i Set-up] menu

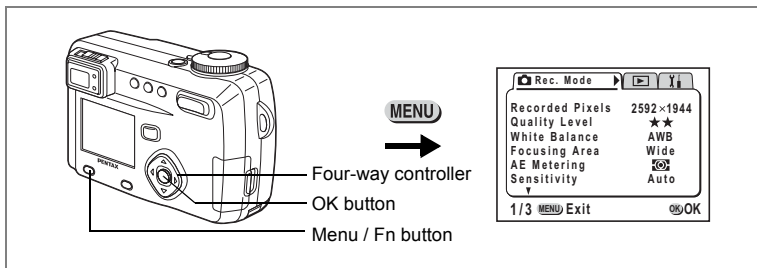

## Changing the Date / Time

You can change the initial date and time settings.

- 1 Select [Date Adjust] on the [i Set-up] menu.
- 2 Press the four-way controller (▶).

The date screen will be displayed.



See “Setting the Date and Time” (p.22) for the setting procedure.

6

## Setting the World Time

The city and time selected in “Initial Settings” (p.20) serve as the Home Time setting.

You can display the time in a city other than the Home Time city (World Time) when shooting or playing back.

- 1 Select [World Time] on the [i Set-up] menu.
- 2 Press the four-way controller (▶).

The World Time screen will be displayed.

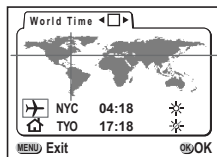

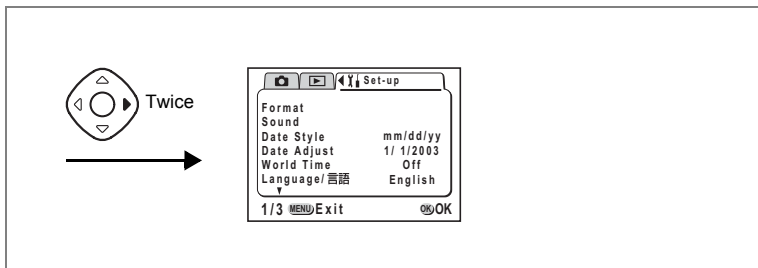

### 3 Switch (On) and (Off) with the four-way controller (◀▶).

- On : The time in the country selected in World Time will be displayed.
- Off : The time in the country selected in Home Time will be displayed.

### 4 Press the four-way controller (▼).

If New York is selected as the world time city, then the cross-shaped line is located in New York on the world map, and then → indicates the current time in New York (NYC).

### 5 Use the four-way controller (◀▶) to select the World Time city and press the four-way controller (▼).

### 6 Set the daylight saving time [DST] to On (☼) or Off (☾) with the four-way controller (◀▶).

### 7 Press the four-way controller (▼).

Tokyo (TYO) is selected as the Home Time city ↕ at first.

### 8 Repeat steps 5 and 6 to change the Home Time city and DST setting.

### 9 Press the OK button twice.

The camera is ready to capture or play back images with the time in the selected city.



See p.128 for the list of cities and code names.

## How to recall the [Yi Set-up] menu

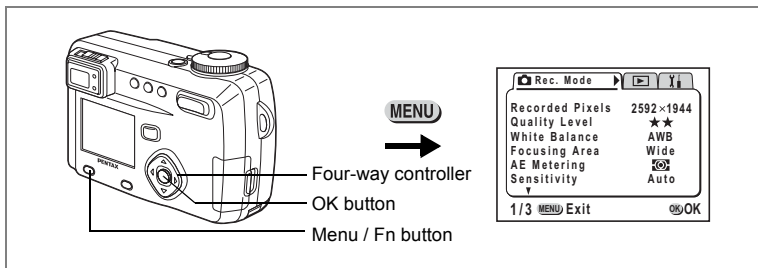

## Changing the Start-up Screen

You can display an image recorded with the camera as the welcome screen when the camera is turned on.

**1 Select [Start-up Screen] on the [Yi Set-up] menu.**

**2 Press the four-way controller (▶).**

The Start-up screen will be displayed.

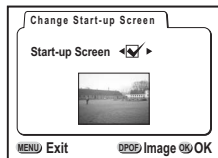

**3 Use the four-way controller (◀▶) to select  (On) or  (Off).**

- The start-up screen is displayed.
- The start-up screen is not displayed.

**4 Press the DPOF button.**

**5 Use the four-way controller (◀▶) to choose the image you want to display as the start-up screen.**

**6 Press the OK button three times.**

The camera is ready to take or play back images.



Once the start-up screen has been set, it will not be erased even if the original image is deleted or the SD Memory Card / MultiMediaCard is formatted. To delete the start-up screen, reset the setting. (p. 125)



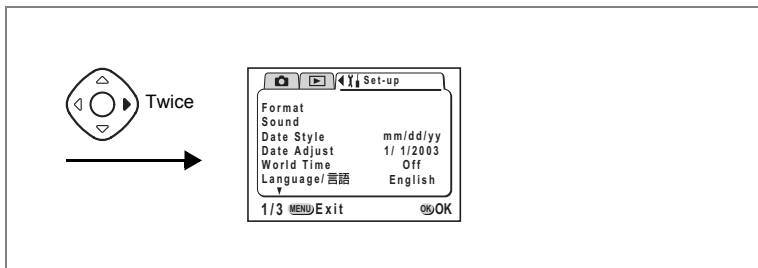

## Changing the Display Language

You can change the language in which the menus, error messages, etc. are displayed.

- 1 Select [Language] on the [Set-up] menu.**
- 2 Use the four-way controller (◀▶) to select the language.**  
The menu will be displayed in selected language.
- 3 Press the OK button.**
- 4 The camera is ready to take or play back images.**

## Changing the Video Output Format

You can select the output format (NTSC or PAL) for taking or playing back images on a TV monitor.

- 1 Select [Video Out] on the [Set-up] menu.**
- 2 Use the four-way controller (◀▶) to change the video output format.**
- 3 Press the OK button.**  
The camera is ready to take or play back images.

## How to recall the [Yi Set-up] menu

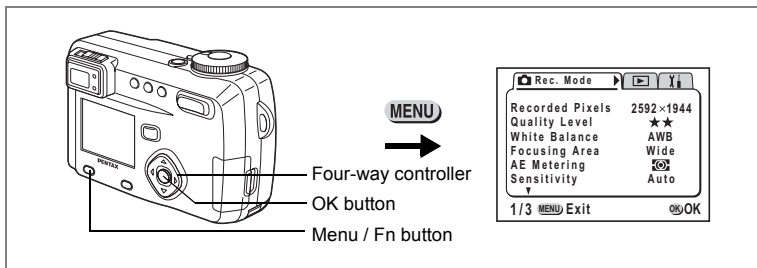

## LCD Power Saving (Sleep Timeout)

You can set the LCD monitor to turn off automatically when no operation is performed for a fixed time.

- 1 Select [Sleep Timeout] on the [Yi Set-up] menu.
- 2 Use the four-way controller (◀▶) to select [30 sec], [1 min], [2 min] or [Off].
- 3 Press the OK button.

The camera is ready to take or play back images.



- This function will not work in Playback mode and using the USB cable and when the camera is operated by optional AC adapter.

## Setting Auto Power Off

You can set the camera to turn off automatically when no operation is performed for a fixed time.

- 1 Select [Auto Power Off] on the [Yi Set-up] menu.
- 2 Use the four-way controller (◀▶) to select [3 min], [5 min] or [Off].
- 3 Press the OK button.

The camera is ready to capture or play back images.



- The menu screen turns off 1 minute after the last operation.
- The Auto Power Off function will not work when the USB cable is connected.

## Setting the Quick Delete Function

The Delete screen will be displayed when [Delete] or [Delete All] is selected when the Quick Delete function is set to On.

- 1 Select [Quick Delete] on the [Set-up] menu.**
- 2 Use the four-way controller (◀▶) to select [On] or [Off].**
- 3 Press the OK button.**

The camera is ready to capture or play back images.

## Setting the Quick Zoom Function

Images can be displayed at the set magnification simply by pressing the Zoom button once during zoom playback when the Quick Zoom function is set to On.

- 1 Select [Quick Zoom] on the [Set-up] menu.**
- 2 Use the four-way controller to (◀▶) select [×2] [×4] [×8] or [OFF].**
- 3 Press the OK button.**

The camera is ready to capture or play back images.

## How to recall the [Yi Set-up] menu

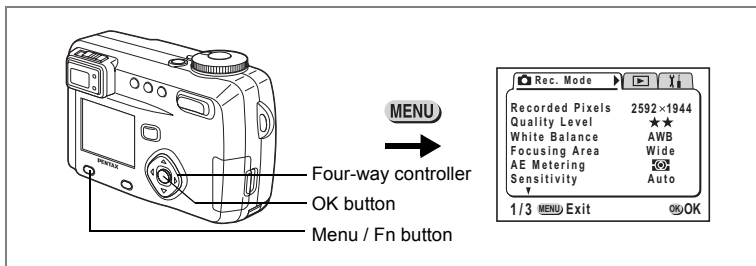

## Registering Functions

You can register the functions you use most frequently on the four-way controller. The functions can then be set directly by pressing the four-way controller without displaying the [Rec.Mode] menu.

### Registering a function

- 1 Select [Fn Setting] on the [Yi Set-up] menu.**
- 2 Press the four-way controller (▶).**  
The Fn Setting screen will be displayed.
- 3 Use the four-way controller (▲▼) to choose the key where you want to register a function.**
- 4 Use the four-way controller (◀▶) to choose the function you want to register.**  
If you do not want to register a function, select Off.
- 5 Press the OK button twice.**  
The camera is ready to capture or play back images.



- Only one function can be registered on each key of the four-way controller.
- You can choose from the following 12 functions: Recorded Pixels, Quality Level, White Balance, Focusing Area, AE Metering, Sensitivity, Flash Exposure Compensation, Digital Zoom, Instant Review, Sharpness, Saturation Contrast.
- In the default setting, a negative level of Flash Exposure Compensation is registered for (◀) and a positive level of Flash Exposure Compensation is registered for (▶).
- If the Flash Exposure Compensation is registered to either (▲) or (▼), levels are compensated positively for (▲) and negatively for (▼).



## Retrieving a function

- 1 Enter the Capture mode and press the Menu / Fn button and the four-way controller key (▲▼◀▶) on which a function is registered at the same time.**
- 2 Press the four-way controller (▲▼◀▶) while pressing the Menu / Fn button to change the setting.**
- 3 Release the Menu / Fn button.**



The setting is saved and the camera is ready to take the picture.



If the flash exposure is set by using the four way controller (▲▼), the four-way controller (▲) can only be designated for compensation increase and the four-way controller (▼) to compensation decrease.

## Checking the status

- 1 Press the Menu / Fn button and the Display button at the same time.**

The function settings will be displayed.



## How to recall the [Yi Set-up] menu

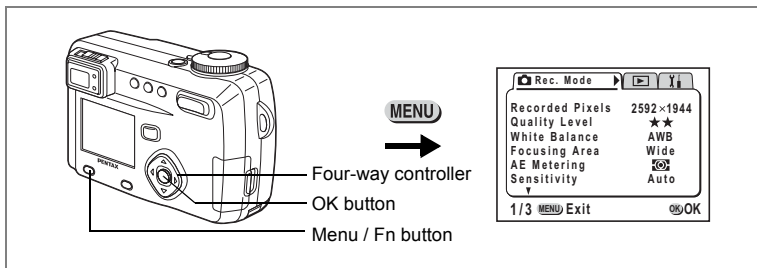

## Adjusting the Focus Limit

You can choose whether or not to limit the movement of the lens when shooting normally and in macro mode.

- 1 Select [Focus Limiter] on the [Yi Set-up] menu.**
- 2 Press the four-way controller (◀▶) to select [On] or [Off].**
- 3 Press the OK button.**

The camera is ready to capture or play back images.

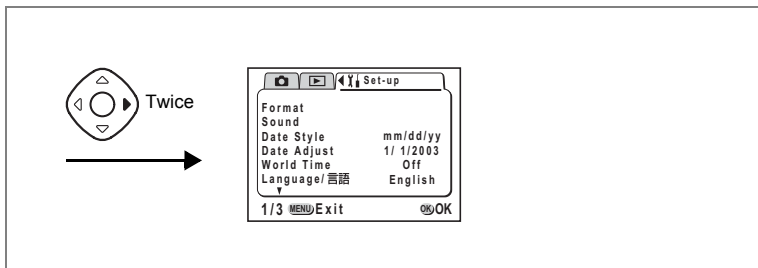

## Resetting to Default Settings (Reset)

You can reset all the settings other than the date and time, language, Video output format, world time and date style.

- 1 Select [Reset] on the [Set-up] menu.**
- 2 Press the four-way controller button (▶).**  
The Reset screen will be displayed.
- 3 Use the four-way controller (▲) to select [Reset].**
- 4 Press the OK button.**  
The camera is ready to capture or play back images.

# Setting the Alarm

You can set the alarm to ring at a specified time and display a selected image.

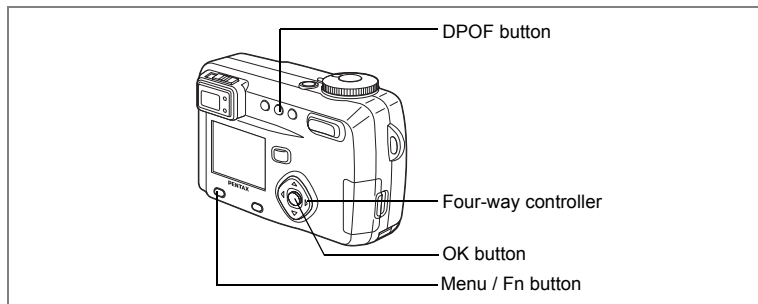

## Checking the Alarm

- 1 Press the Menu / Fn button.**
- 2 Press the four-way controller (▶).**  
The [▶ Playback] menu will be displayed.
- 3 Press the four-way controller (▲▼) to select [Alarm].**
- 4 Press the four-way controller (▶).**  
The list of alarms will be displayed.  
Active alarms are indicated by .
- 5 Press the OK button twice.**  
If any alarms are enabled, the camera will be turned off and the alarms will be set.

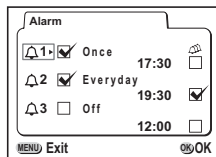

## Setting the Alarm

- 1 Press the Menu / Fn button.**
- 2 Press the four-way controller (▶).**  
The [▶ Playback] menu will be displayed.
- 3 Press the four-way controller (▲▼) to select [Alarm].**



#### 4 Press the four-way controller (▶).

The list of alarms will be displayed.

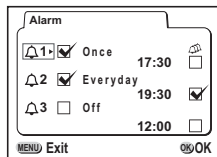

#### 5 Press the four-way controller (▲▼) to select alarm 1-3.

#### 6 Press the four-way controller (▶).

The screen for setting the alarm mode and time will be displayed.

Four-way controller (◀▶): Selects the item.

Four-way controller (▲▼): Changes the setting.



If the Snooze (🔔) is set to  (on), the alarm will ring 5 times at 5 minutes intervals.'

#### 7 Press the DPOF button.

#### 8 Press the four-way controller (◀▶) to select the image to be displayed when the alarm rings.

#### 9 Press the OK button.

#### 10 Press the OK button 3 times.

The camera will turn off.

## Turning the Alarm Off

The alarm will ring for one minute when the camera is turned off and the set time is reached.

The camera will turn off automatically when the alarm has finished ringing.



- To stop the alarm ringing, press any button.
- To cancel the Snooze function, press the Menu / Fn button and OK button at the same time.



The alarm will not ring when the camera is turned on.

## List of City Names

Refer to following list of city and code names for setting the world time.

Region	City	Code	Region	City	Code
EUROPE	Madrid	MAD	ASIA	Shanghai	SHA
	London	LON		Manila	MNL
	Paris	PAR		Taipei	TPE
	Milano	MIL		Seoul	SEL
	Rome	ROM		Tokyo	TYO
	Berlin	BER	OCEANIA	Pagopago	PPG
	Moscow	MOW		Perth	PER
AFRICA	Johannesburg	JNB		Adelaide	ADL
	Cairo	CAI		Sydney	SYD
MIDDLE EAST	Istanbul	IST		Noumea	NOU
	Jerusalem	JRS		Wellington	WLG
	Jeddah	JED		Auckland	AKL
	Tehran	THR	NORTH AMERICA	Guam	GUM
	Dubai	DXB		Honolulu	HNL
Kabul	KBL	Anchorage		ANC	
ASIA	Karachi	KHI		San Francisco	SFO
	Male	MLE		Los Angeles	LAX
	Delhi	DEL		Denver	DEN
	Colombo	CMB		Chicago	CHI
	Kathmandu	KTM		Miami	MIA
	Dacca	DAC		New York	NYC
	Rangoon	RGN		Vancouver	YVR
	Bangkok	BKK		Calgary	YYC
	Kuala Lumpur	KUL		Toronto	YTO
	Vientiane	VTE		Halifax	YHZ
	Singapore	SIN	CENTRAL & SOUTH AMERICA	Mexico City	MEX
	Phnom Penh	PNH		Santiago	SCL
	Ho chi Minh	SGN		Caracas	CCS
	Jakarta	JKT		Buenos Aires	BUE
	Hong Kong	HKG		Sao Paulo	SAO
Beijing	BJS	Rio de Janeiro	RIO		

# List of Menu Default Settings

## ● [📷 Rec.Mode] Menu

item	Default Setting
Recorded Pixels	2592 × 1944 (📷: 320 × 240)
Quality Level	★★
White Balance	AWB (Auto)
Focusing Area	Wide
AE Metering	📷
Sensitivity	Auto
Flash Exp. Comp.	0.0
Auto Bracket	–
Digital Zoom	On
Instant Review	2 sec
Interval Shooting	–
Fast Fwd Movie	Off
3D Mode	Parallel
Memory	–
Sharpness	Normal
Saturation	Normal
Contrast	Normal
USER	<b>P</b>

## ● [▶ Playback] Menu

item	Default Setting
Resize	–
Trimming	–
Digital Filter	BW
Alarm	[Off]
Slideshow	3 sec (3 sec. intervals)
PictBridge	–

## ● [Fn Set-up] Menu

item	Default Setting
Format	–
Sound	–
Date Style	mm/dd/yy/
Date Adjust	2003/01/01
World Time	Off
Language/言語	English
Start-up Screen	On
Video Out	NTSC
Sleep Timeout	1 min
Auto Power Off	3 min.
Quick Delete	Off
Quick Zoom	Off
Fn Setting	Fn + ◀, Fn + ▶ (Flash Exp. comp.)
Focus Limiter	On
Reset	–

# Adjustable [Rec.Mode] Menu Items by Capture Mode

○:Changes are reflected in all camera operations

×:Only default setting is reflected in camera operations; changes are invalid

Item	M	Tv	Av	P	PICT	■■■	3D	①	📷	🎤
Recorded Pixels	○	○	○	○	○	○	○	○	320×240	×
Quality Level	○	○	○	○	○	○	○	○	×	×
White Balance	○	○	○	○	○	○	○	○	○	×
Focusing Area	○	○	○	○	○	○	○	○	×	×
AE Metering	○	○	○	○	○	○	○	○	○	×
Sensitivity	○	○	○	○	○	○	○	○	×	×
Flash Exp. Comp.	○	○	○	○	○	○	○	○	×	×
Auto Bracket	○	○	○	○	○	×	×	○	×	×
Digital Zoom	○	○	○	○	○	○	○	○		×
Instant Review	○	○	○	○	○	○	○	○	×	×
Interval Shoot	○	○	○	○	○	×	×	○	×	×
Fast Fwd Movie	×	×	×	×	×	×	×	×	○	×
3D Mode	×	×	×	×	×	×	○	×	×	×
Memory	○	○	○	○	○	○	○	○	×	×
Sharpness	○	○	○	○	×	○	○	○	○	×
Saturation	○	○	○	○	×	○	○	○	○	×
Contrast	○	○	○	○	×	○	○	○	○	×
USER	×	×	×	×	×	×	×	×	×	×



- Settings for items marked with an [×] can be changed on the menu screen, but the change will not be reflected in camera operations.
- In **USER** mode, only the settings marked with an [○] can be changed in the register.

# Messages

Messages such as the following may be displayed on the LCD monitor during camera operation.







Memory card full	The SD Memory Card / MultiMediaCard memory is full and no more images and sound can be saved. Insert a new SD Memory Card / MultiMediaCard or delete unwanted images. (p.16, p.96) Change the quality / size and try again. (p.43, p.44)
No image & sound	There are no images and sound on the SD Memory Card / MultiMediaCard to playback.
Camera can not display this image.	You are trying to play back an image in a format not supported by this camera. You may be able to display it on another brand of camera or PC.
No card in camera.	There is no SD Memory Card / MultiMediaCard in the camera. (p.16)
Battery depleted.	The battery is exhausted. Charge the D-LI7 battery using D-BC7 battery charger or replace with a charged battery. (p.12, p.13)
Memory card error.	Shooting and playback are impossible due to a problem with SD Memory Card / MultiMediaCard. Try displaying on a PC.
This card is not formatted.	The SD Memory Card / MultiMediaCard you have inserted is unformatted or has been formatted on a PC or other device and is not compatible with the camera.
Image recording.	The image / voice recording is being recorded on the SD Memory Card / MultiMediaCard.
Data being recorded.	The movie picture is being recorded on the SD Memory Card / MultiMediaCard.
No images for filter	Displayed when a TIFF image is selected, or when you try to apply a filter effect to an image that has not been saved to a SD Memory Card / MultiMedia Card.
Formatting	The SD Memory Card / MultiMediaCard is being formatted.

Deleting	The image is being deleted.
Image folder could not be created.	The largest file number is assigned to an image and no more images can be saved. Insert a new SD Memory Card / MultiMediaCard or format the SD Memory Card / MultiMediaCard. (p.112)
This card is not formatted.	The SD Memory Card / MultiMedia Card you have inserted is unformatted, or has been formatted on a PC or other device and is not compatible with this camera. (p.112)
Compression error	Compression of the image you captured has failed. Change the recorded pixels or quality levels, and take a picture again.
Data being recorded	The movie picture is being recorded.
Image protected	The image you are trying to delete is a protected image. (p.99)
Alarm set	The alarm has been enabled.
No DPOF files	Displayed when the DPOF button is pressed in PictBridge mode and there are no DPOF settings for an image. Select the DPOF settings for the image.
Printer error / Print aborted	Displayed when a printer error occurs in PictBridge mode.
Connect camera & printer	Displayed when PictBridge is selected from the Playback menu.
No image	Displayed in PictBridge mode when there are no images that can be printed saved in a SD Memory Card / MultiMedia Card.
Safely remove USB cable	Displayed when you choose not to continue printing in PictBridge mode.

# Troubleshooting

Problem	Cause	Remedy
Power will not come on	Battery is not installed	Check battery is installed. If not, install battery.
	Battery is installed incorrectly	Check orientation of battery. Reinsert battery with the label towards front of camera. (p.13)
	Battery power is low	Insert a charged battery or use the AC adapter.
No image on the LCD monitor	LCD monitor is set to OFF	Press Display button to turn LCD monitor on. (p.38)
	Connected to PC by USB cable.	When connecting to PC, LCD monitor is always On.
	Camera is connected to TV	LCD monitor remains off while camera is connected to TV.
Shutter will not be released	Image is displayed but is hard to see	Image on LCD monitor may be hard to see when taking pictures outside in sunlight.
	Flash is charging	When flash lamp blinks red, flash is charging and no pictures can be taken. Lamp lights red when charging is completed.
	No available space on SD Memory Card / MultiMediaCard Insert SD Memory Card /	MultiMediaCard with available space or delete unwanted images. (p.16, 96)
	Recording	Wait until recording is finished.
Zoom does not work	Super Macro mode has been set.	The zoom is disabled in this mode.



Problem	Cause	Remedy
Subject is not in focus	Subject difficult to focus on	Subjects difficult to focus on using autofocus: objects with little contrast (blue sky, white walls, etc.), dark objects, finely patterned objects, fast-moving objects, scenery through window or net, etc. Lock focus on another object located at same distance (press shutter release button halfway), then aim at target and press shutter release button fully.
	Subject is not in focusing area	Position subject in AF frame (focusing area) in middle of LCD monitor. If the subject is outside the focusing area, aim the camera at the subject and lock focus (press shutter release button halfway), then compose picture and press the shutter release button fully.
	Subject is too close	Set focus mode on  . (p.40)
	Focus mode is set on 	Focus mode is set on  .
Picture is dark	Subject is too far away in a dark environment, such as a night scene.	Picture becomes dark if subject is too far away. Take picture within range of flash.
	Background is dark	When taking a picture of a person against dark background, such as night scene, the person may appear dark if the flash does not reach background even with correct exposure. Set to  mode to ensure both person and background are clear. (p.60)
Flash does not fire	Flash mode is set to Off	Set to Auto or  . (p.42)
	The Capture mode is set to  , super macro, continuous shooting or infinity-landscape mode, or the Picture mode is set to Fireworks mode.	Flash will not fire in these modes.

# Main Specifications

Type	Fully automatic compact-type digital still camera with built-in zoom lens	
Effective Pixels	5.0 megapixels	
Sensor	5.25 megapixels (total pixels) 1/1.8 inch interline transfer CCD with a primary color filter	
Recorded Pixels	Still	2592 × 1944 pixels, 2048 × 1536 pixels, 1600 × 1200 pixels, 1024 × 768 pixels, 640 × 480 pixels
	Movie	320 × 240 pixels
Sensitivity	Auto, manual (equivalent to ISO 64, 100, 200, 400)	
File Format	Still	JPEG (Exif2.2), TIFF, DCF, DPOF, PRINT Image Matching II
	Movie	Mov (Quick Time Motion), 15fps
Quality Level	"TIFF", "Good", "Better", "Best"	
Storage Medium	SD Memory Card, MultiMediaCard	
Image Storage Capacity		

Quality levels Recorded pixels	Quality levels			Movie images (320 × 240)	Voice recording
	TIFF	Best (★★★)	Better (★★)		
2595 × 1944	0	Approx. 4	Approx. 8	Approx. 14	Approx. 40
2048 × 1536	–	Approx. 7	Approx. 12	Approx. 18	
1600 × 1200	–	Approx. 11	Approx. 20	Approx. 27	
1024 × 768	–	Approx. 25	Approx. 45	Approx. 56	
640 × 480	–	Approx. 53	Approx. 82	Approx. 100	

- When using a 16MB SD Memory Card

White Balance	Auto, Daylight, Shade, Tungsten Light, Fluorescent Light (W), Fluorescent Light (N), Fluorescent Light (D), Manual	
Lens	Focal Length	7.8 mm – 39 mm (Equivalent to 37.5 mm – 187.5 mm in 35 mm format)
	Max. aperture	f/2.8 – f/4.6
	Lens Composition	9 elements in 7 groups (two aspherical elements)
	Zoom type	Electrically driven
	Picture Range	33.7 mm × 24.7 mm (screen is filled) (using super macro mode or manual focus at max, WIDE position)
	Lens Barrier	Electrically driven
Digital Zoom	Capture mode	Max. 4× (Combines with 5× optical zoom to give zoom magnification equivalent to 20×)
Viewfinder	Type	Real-image zoom viewfinder (Diopter adjustment in the range of –3 to +1m <sup>-1</sup> )
	Magnification	Wide 0.37×, Tele 1.66×
LCD Monitor	1.5 inch low-temperature polysilicon TFT color LCD monitor with 113 kilo pixels (with backlight)	

Playback Function	Single-frame, 9-frame index, enlargement (max. 8×), scroll, slideshow, Display rotated images, movie playback, voice playback, histogram display, trimming, resize	
Focusing System	Type	TTL contrast detection system by sensor with external passive sensor
	Focusing Range (From lens front)	Normal: 0.6 m (1.97 ft) to infinity (full zoom range) Macro: 0.15 m (0.50 ft) – 0.65 m (2.13 ft) (full zoom range) Super macro: 0.02 m (0.8 in.) – 0.65 m (2.13 ft) (Wide only) Landscape: Infinity (full zoom range)
	Focus Lock	By half-pressing shutter release button
Manual Focus	0.15 m (0.50 ft) to infinity (full zoom range), 0.02 m (0.8 in.) to infinity (Wide only)	
Exposure Mechanism	AE Metering	TTL metering by sensor (Multi-segment, Center-weighted, Spot)
	Exposure Compensation	±2 EV (Set in 1/3 EV steps)
	Movie	Recording time approx. 1 sec. – 10 min.
	Auto Bracket	Possible
	Exposure Modes	Program, Av, Tv, M, PICT, Movie, Panorama Assist, 3D, Digital Filter, USER, Voice Recording
Shutter	Type	Electronic / mechanical shutter
	Speed	Approx. 1/2000 sec. – 15 sec.
Flash	Type	Auto flash with red-eye reduction function
	Flash Modes	Auto, Flash Off, Flash On, Auto + Red-eye reduction, Flash On + Red-eye Reduction
	Light Compensation	±2 EV (in 1/3 EV steps)
	Working Range	Wide: Approx. 0.4 m – 5.2 m (1.31 ft – 17.1 ft) Tele: Approx. 0.15 m – 3.2 m (0.50 ft – 10.5 ft)
Drive Modes	Single-frame, Self-timer, Remote Control after 3 Seconds, Remote Control, Continuous, Interval, Multiple Exposure	
Self-timer	Electronic control type, delay time: approx. 10 sec.	
Remote Control Unit	Pentax Remote Control Unit F (optional) Exposure 3 seconds after receipt of signal or instant exposure	
Time function	World Time setting for 62 cities (28 time zones)	
Power Supply	Rechargeable lithium-ion battery D-Li7, AC adapter (optional)	
Battery life w / fully charged	Approx. 400 with 50% of shooting uses flash, LCD monitor ON in accordance with Pentax measuring conditions.	
In / Out Port	USB / AV terminal (PC communication type USB1.1), external power supply terminal	
Video Output Format	NTSC, PAL	
Direct Printing	PictBridge supported	
Size	100 (W) × 59 (H) × 39.5 (D) mm (excluding operating members)	
Weight	205 g (excluding battery and SD Memory Card / MultiMediaCard)	
Weight when shooting	250 g (including battery and SD Memory Card / MultiMediaCard)	
Accessories	Rechargeable lithium-ion battery, battery charger, USB cable, AV cable, 3D image viewer, software (CD-ROM), strap, operating manual	

# Optional Accessories

A number of dedicated accessories are available for this camera.

**Rechargeable lithium-ion battery (D-LI7)**

**Battery charger (D-BC7)**

**AC adapter (D-AC7)**

**AC Plug Cord**

D-CO2A Australia

D-CO2B United Kingdom

D-CO2E Europe

D-CO2H Hong Kong

D-CO2J Japan

D-CO2K Korea

D-CO2U North America, Canada

**USB Cable (I-USB7)**

**AV Cable (I-AVC7)**

**Camera Case (O-CC7)**

**Strap (O-ST5)**

**Remote Control Unit F**

# WARRANTY POLICY

All Pentax cameras purchased through authorized bona fide photographic distribution channels are guaranteed against defects of material or workmanship for a period of twelve months from date of purchase. Service will be rendered, and defective parts will be replaced without cost to you within that period, provided the equipment does not show evidence of impact, sand or liquid damage, mishandling, tampering, battery or chemical corrosion, operation contrary to operating instructions, or modification by an unauthorized repair shop. The manufacturer or its authorized representatives shall not be liable for any repair or alterations except those made with its written consent and shall not be liable for damages from delay or loss of use or from other indirect or consequential damages of any kind, whether caused by defective material or workmanship or otherwise; and it is expressly agreed that the liability of the manufacturer or its representatives under all guarantees or warranties, whether expressed or implied, is strictly limited to the replacement of parts as hereinbefore provided. No refunds will be made on repairs by non-authorized Pentax service facilities.

## Procedure During 12-month Warranty Period

Any Pentax which proves defective during the 12-month warranty period should be returned to the dealer from whom you purchased the equipment or to the manufacturer. If there is no representatives of the manufacturer in your country, send the equipment to the manufacturer, with postage prepaid. In this case, it will take a considerable length of time before the equipment can be returned to you owing to the complicated customs procedures required. If the equipment is covered by warranty, repairs will be made and parts replaced free of charge, and the equipment will be returned to you upon completion of servicing. If the equipment is not covered by warranty, regular charges of the manufacturer or of its representatives will apply. Shipping charges are to be borne by the owner. If your Pentax was purchased outside of the country where you wish to have it serviced during the warranty period, regular handling and servicing fees may be charged by the manufacturer's representatives in that country. Notwithstanding this, your Pentax returned to the manufacturer will be serviced free of charge according to this procedure and warranty policy. In any case, however, shipping charges and customs clearance fees to be borne by the sender. To prove the date of your purchase when required, please keep the receipt or bills covering the purchase of your equipment for at least a year. Before sending your equipment for servicing, please make sure that you are sending it to the manufacturer's authorized representatives or their approved repair shops, unless you are sending it directly to the manufacturer. Always obtain a quotation for the service charge, and only after you accept the quoted service charge, instruct the service station to proceed with the servicing.

- **This warranty policy does not affect the customer's statutory rights.**
- **The local warranty policies available from Pentax distributors in some countries can supersede this warranty policy. Therefore, we recommend that you review the warranty card supplied with your product at the time of purchase, or contact the PENTAX distributor in your country for more information and to receive a copy of the warranty policy.**

**For customers in USA****STATEMENT OF FCC COMPLIANCE**

This device complies with Part 15 of the FCC Rules. Operation is subject to the following two conditions: (1) This device may not cause harmful interference, and (2) this device must accept any interference received, including interference that may cause undesired operation. Changes or modifications not approved by the party responsible for compliance could void the user's authority to operate the equipment. This equipment has been tested and found comply with the limits for a Class B digital device, pursuant to part 15 of the FCC Rules.

These limits are designed to provide reasonable protection against harmful interference in a residential installation. This equipment generates, uses and can radiate frequency energy and, if not installed and used in accordance with the instructions, may cause harmful interference to radio communications. However, there is no guarantee that interference will not occur in a particular installation.

If this equipment does cause harmful interference to radio or television reception, which can be determined by turning the equipment off and on, the user is encouraged to try to correct the interference by one or more of the following measures:

- Reorient or relocate the receiving antenna.
- Increase the separation between the equipment and receiver.
- Connect the equipment into an outlet on a circuit different from that to which the receiver is connected.
- \* Consult the dealer or an experienced radio / TV technician for help.

**For customers in Canada**

This Class B digital apparatus meets all requirements of the Canadian Interference - Causing Equipment Regulations.

**Pour les utilisateurs au Canada**

Cet appareil numérique de la classe B respecte toutes les exigences du Règlement sur le matériel brouilleur du Canada.



The CE Mark is a Directive conformity mark of the European Community.

**Declaration of Conformity**  
According to 47CFR, Parts 2 and 15 for  
**Class B Personal Computers and Peripherals**

We: PENTAX U.S.A., Inc.

Located at: 600 12<sup>th</sup> Street, Suite 300  
Golden, Colorado 80401 U.S.A.  
Phone: 303-799-8000 FAX: 303-790-1131

Declare under sole responsibility that the product identified herein, complies with 47CFR Parts 2 and 15 of the FCC rules as a Class B digital device. Each product marketed, is identical to the representative unit tested and found to be compliant with the standards. Records maintained continue to reflect the equipment being produced can be expected to be within the variation accepted, due to quantity production and testing on the statistical basis as required by 47CFR §2.909. Operation is subject to the following two conditions: (1) This device may not cause harmful interference, and (2) This device must accept any interference received, including interference that may cause undesired operation. The above named party is responsible for ensuring that the equipment complies with the standards of 47CFR §15.101 to §15.109.

Product Name: PENTAX Digital Still Camera

Model Number: Optio 555

Contact person: Customer Service Manager

Date and Place: September, 2003, Colorado

<b>PENTAX Corporation</b>	2-36-9, Maeno-cho, Itabashi-ku, Tokyo 174-8639, JAPAN ( <a href="http://www.pentax.co.jp/">http://www.pentax.co.jp/</a> )
<b>PENTAX Europe GmbH (European Headquarters)</b>	Julius-Vosseler-Strasse, 104, 22527 Hamburg, GERMANY (HQ - <a href="http://www.pentaxeuropa.com">http://www.pentaxeuropa.com</a> ) (Germany - <a href="http://www.pentax.de">http://www.pentax.de</a> )
<b>PENTAX U.K. Limited</b>	PENTAX House, Heron Drive, Langley, Slough, Berks SL3 8PN, U.K. ( <a href="http://www.pentax.co.uk">http://www.pentax.co.uk</a> )
<b>PENTAX France S.A.S.</b>	12/14, rue Jean Poulmarch, 95106 Argenteuil Cedex, FRANCE
<b>PENTAX Benelux B.V.</b>	(for Netherlands) Spinveld 25, 4815 HR Breda, NETHERLANDS ( <a href="http://www.pentax.nl">http://www.pentax.nl</a> ) (for Belgium & Luxembourg) Weiveldlaan 3-5, 1930 Zaventem, BELGIUM ( <a href="http://www.pentax.be">http://www.pentax.be</a> )
<b>PENTAX (Schweiz) AG</b>	Widenholzstrasse 1 Postfach 367 8305 Dietlikon, SWITZERLAND ( <a href="http://www.pentax.ch">http://www.pentax.ch</a> )
<b>PENTAX Scandinavia AB</b>	P.O. Box 650, 75127 Uppsala, SWEDEN ( <a href="http://www.pentax.se">http://www.pentax.se</a> )
<b>PENTAX U.S.A., Inc</b>	600 12 <sup>th</sup> Street, Suite 300 Golden, Colorado 80401, U.S.A. ( <a href="http://www.pentax.com">http://www.pentax.com</a> )
<b>PENTAX Canada Inc.</b>	3131 Universal Drive, Mississauga, Ontario L4X 2E5, CANADA ( <a href="http://www.pentaxcanada.ca">http://www.pentaxcanada.ca</a> )



for your  
precious moments

- Printed on recycled paper
- Specifications and external dimensions are subject to change without notice.

57323

Copyright © PENTAX Corporation 2003  
02-200310 Printed in Japan